



















ТЕХНИКА В ДВИЖЕНИИ



MACO PROTECT ДВЕРНЫЕ ЗАМКИ



Каталог

| | | | |
|---|--|---|--|
|  | Артикул |  | Количество запорных цапф |
|  | Норма упаковки |  | Размеры угловой фалевой ригельной планки |
|  | Высота створки по фальцу FFH | G-TS = | Дверной замок с приводом от ручки |
|  | Ширина створки по фальцу FFB | Z-TS = | Дверной замок с приводом от цилиндра |
|  | Ширина и высота створки по фальцу | Z-TF = | Дверной замок с 3 фалевыми защёлками с приводом от цилиндра |
|  | Высота расположения ручки GM | MF = | Мультифункциональная фалевая защёлка |
|  | Расстояние от центра вращения ручки до центра цилиндра | ZS = | Дополнительный замок |
|  | Дорнмас | B-TV = | Замок для балконной двери |
|  | Размер штифта | MM = | Multi-Matic |
|  | Ширина штульпа | U = | U-штульп |
|  | Длина шпингалета | PZ = | Профильный цилиндр |
|  | Ход стержня | RZ = | Круглый цилиндр |
|  | Ширина стержня | i.S. = | Взломостойкие i.S. цапфы |
|  | Фальцлюфт (4 мм/12 мм) | VZ = | Запорные цапфы |
|  | Радиус | HO = | Направление запираения крюков - вверх |
|  | Длина элемента | BO = | Штыри |
|  | Количество взломостойких i.S. цапф | HO-BO = | Комбинация крюки-штыри |
| | | MF-BO = | Комбинация мультифункциональные защёлки-штыри |
| | | SFG = | Штульповой механизм |
| | | EV = | Концевой запор |
| | | K+ = | Позиционирование коробки замка с запорными элементами над ручкой |

Если нет дополнительных указаний, то размеры указываются в мм, а норма упаковки в количестве штук в коробке.



Техника в движении

ООО "МАКО ФУРНИТУРА"
248033 КАЛУГА, РФ
УЛ. ТУЛЬСКОЕ ШОССЕ, 10

Уважаемые дамы и господа!

Этот "Краткий каталог MACO" составлен, чтобы предоставить Вам исчерпывающее представление о нашей программе фурнитуры. Для того, чтобы мы могли постоянно вовремя информировать Вас о дополнениях и изменениях – если это необходимо – следует заполнить анкету-ответ, находящуюся перед Вами. **Из Каталога MACO можно получить всю информацию не только о возможности заказа, но и соответствующие указания по применению, данные самой продукции в смысле качественных показателей**

Для того чтобы по возможности быстро осуществлять необходимые дополнения и изменения, нам необходимо точно знать владельца каталога. Заказы по каталогу следуют, в основном, по указанному ниже адресу, лично в руки.

Пожалуйста, заполнить полностью:

| Мы подтверждаем получение и принимаем к сведению: | |
|--|--|
| <p><i>Штамп фирмы:</i></p> <p><i>Точный адрес, телефоны:</i></p> | <p>_____</p> <p><i>Получено экземпляров каталога</i></p> <p>_____</p> <p><i>Пожалуйста, укажите Вашу фамилию печатными буквами</i></p> |
| <p>Дата: _____ Подпись: _____</p> | |

Сотрудник фирмы MACO _____

По всем возникающим вопросам просим Вас обращаться в ближайшее к Вам Представительство фирмы MACO по адресам, указанным на последней странице обложки "Краткого каталога".



Техника в движении

ООО "МАКО ФУРНИТУРА"
248033 КАЛУГА, РФ
УЛ. ТУЛЬСКОЕ ШОССЕ, 10

Уважаемые дамы и господа!

Этот "Краткий каталог MACO" составлен, чтобы предоставить Вам исчерпывающее представление о нашей программе фурнитуры. Для того, чтобы мы могли постоянно вовремя информировать Вас о дополнениях и изменениях – если это необходимо – следует заполнить анкету-ответ, находящуюся перед Вами. **Из Каталога MACO можно получить всю информацию не только о возможности заказа, но и соответствующие указания по применению, данные самой продукции в смысле качественных показателей**

Для того чтобы по возможности быстро осуществлять необходимые дополнения и изменения, нам необходимо точно знать владельца каталога. Заказы по каталогу следуют, в основном, по указанному ниже адресу, лично в руки.

Пожалуйста, заполнить полностью:

| Мы подтверждаем получение и принимаем к сведению: | |
|--|--|
| <p>Штамп фирмы:</p> <p>Точный адрес, телефоны:</p> | <p style="text-align: center;">_____</p> <p style="text-align: center;"><i>Получено экземпляров каталога</i></p> <p style="text-align: center;">_____</p> <p style="text-align: center;"><i>Пожалуйста, укажите Вашу фамилию печатными буквами</i></p> |
| Дата: _____ | Подпись: _____ |

Сотрудник фирмы MACO _____

По всем возникающим вопросам просим Вас обращаться в ближайшее к Вам Представительство фирмы MACO по адресам, указанным на последней странице обложки "Краткого каталога".



| | | |
|-----------|--|-----------|
| 1 | Дверные замки G-TS PT | 1 |
| 2 | Дверные замки Z-TS Modul PT | 2 |
| 3 | Дверные замки Z-TF PT | 3 |
| 4 | Запорные планки и шульпы запорных планок | 4 |
| 5 | Концевые запоры для дверных замков | 5 |
| 6 | Штульповые механизмы и дверные шпингалеты | 6 |
| 7 | Принадлежности и шаблоны | 7 |
| 8 | Дверные замки B-TV | 8 |
| 9 | Шпингалет для межкомнатных дверей | 9 |
| 10 | Технические данные и документация | 10 |

**MACO
PROTECT**





1 Дверные замки G-TS PT

| | | |
|-----|-----------------------------|----|
| 1.1 | Схема обвязки замка G-TS PT | 8 |
| 1.2 | E92 Штульп F-16 | 11 |
| 1.3 | E92 Штульп F-20 | 17 |

1 Дверные замки G-TS PT

1.1 Схема обвязки замка G-TS PT

4 i.S цапфы

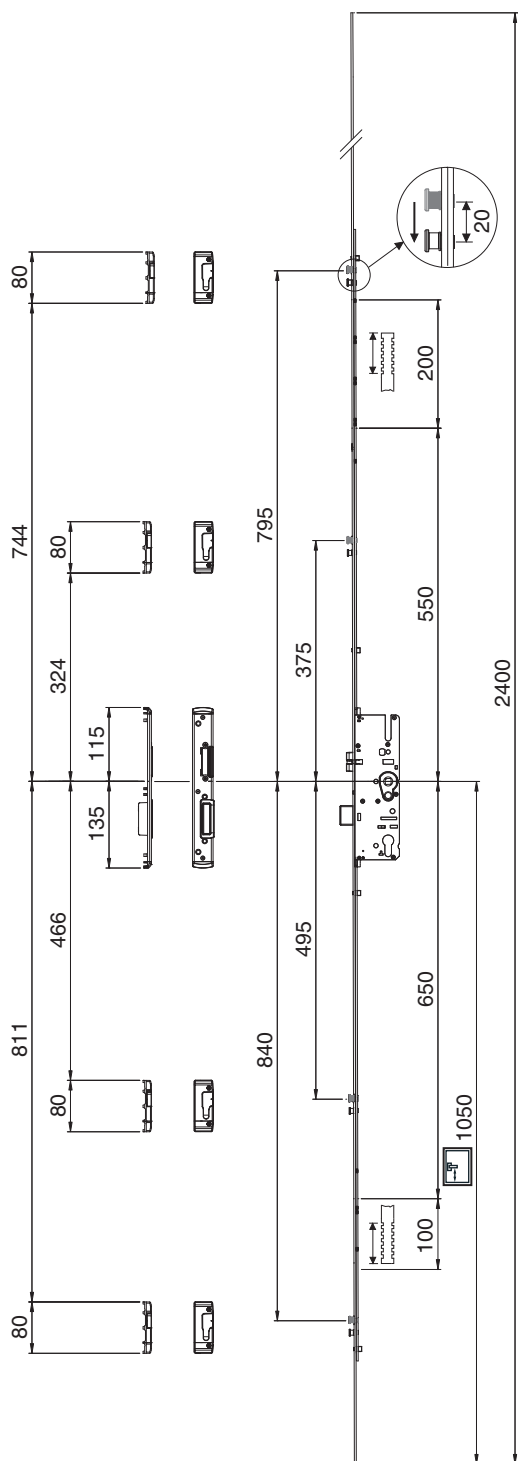

2 крюка

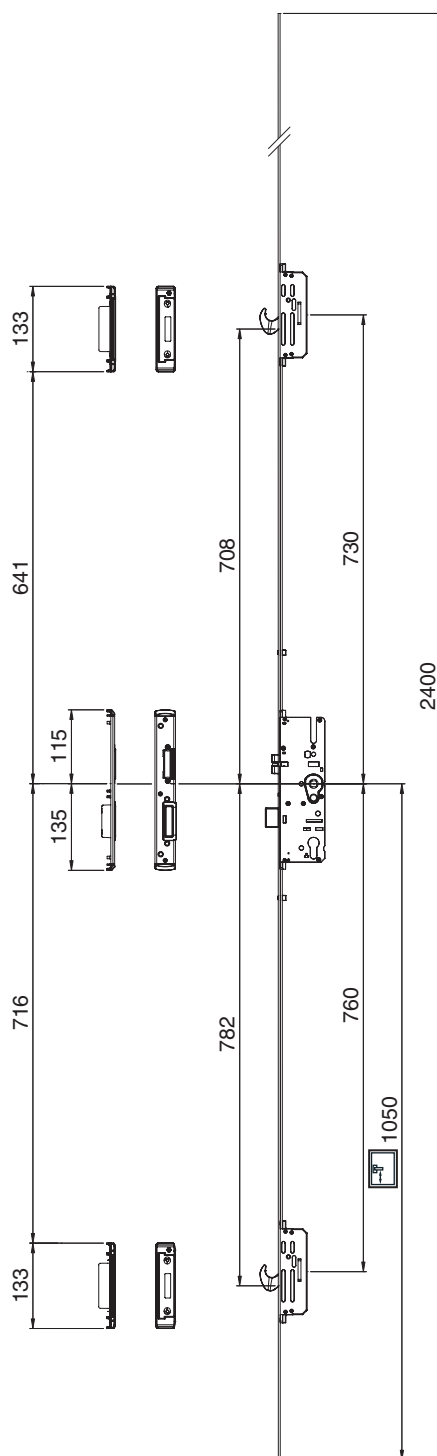

2 штыря

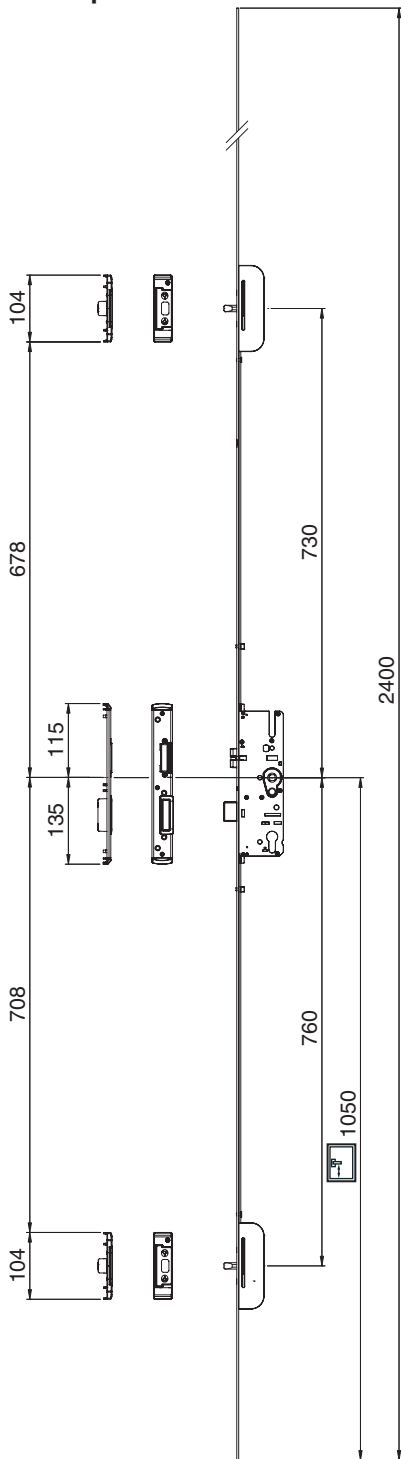

2 крюка + 2 i.S. цапфы

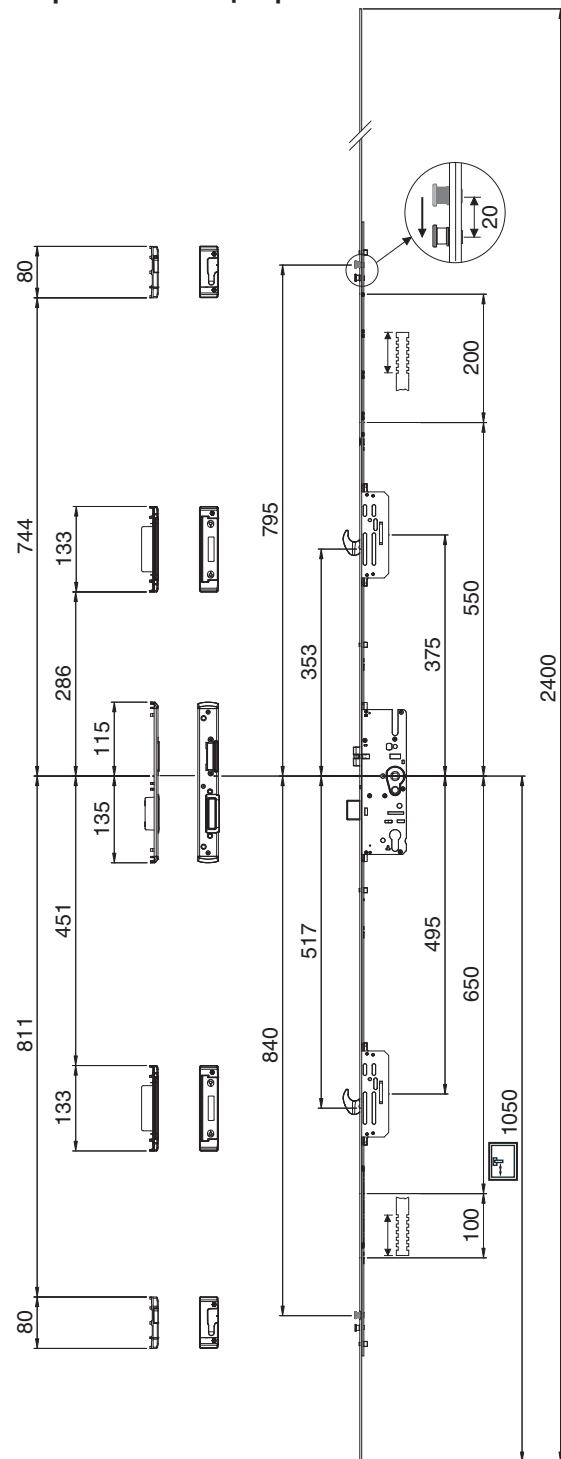



2 штыря + 2 i.S. цапфы

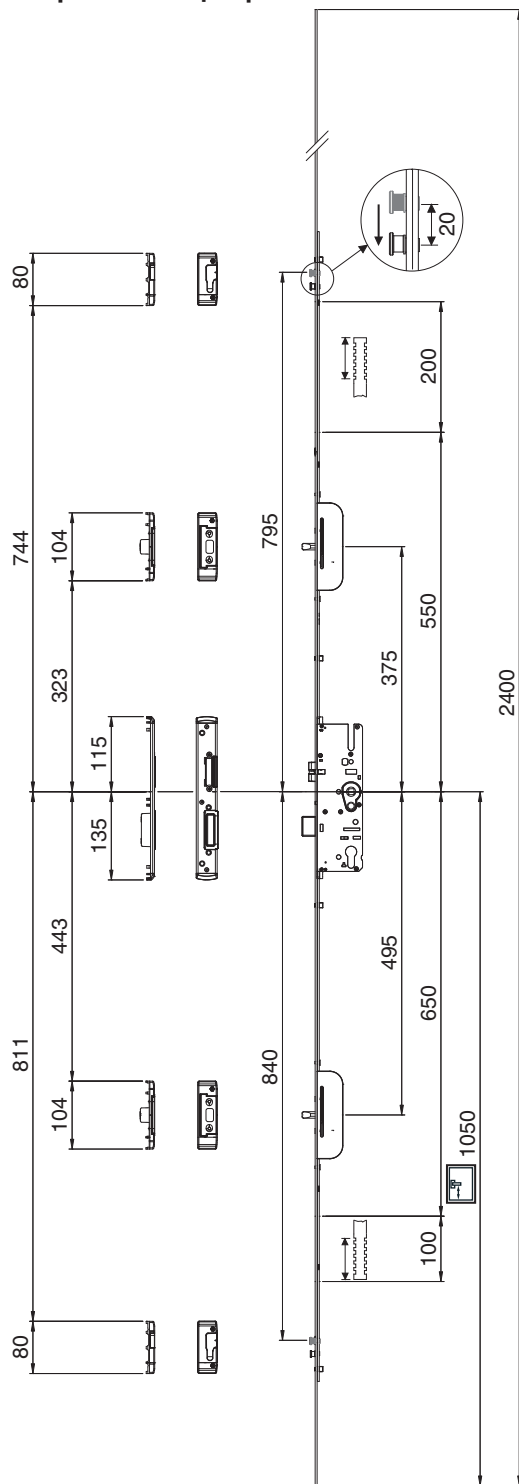

1.2 E92 Штульп F-16

232015





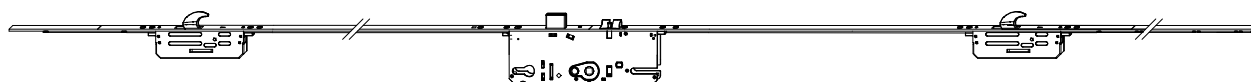

| 1.2.1 Дверной замок G-TS PT с 4 i.S. цапфами Штульп F-16 | | | | | | | L | | № | € |
|--|----|----|-------|---------------|---------------|-------|-------|--------|--------|---|
| удлин. | 92 | 28 | 8 | 1.050 | 1.950 - 2.400 | 16 | 2.400 | 5 | 232010 | |
| | | 10 | 1.050 | 1.950 - 2.400 | 16 | 2.400 | 5 | 232500 | | |
| | 35 | 8 | 1.050 | 1.950 - 2.400 | 16 | 2.400 | 5 | 232011 | | |
| | | 10 | 1.050 | 1.950 - 2.400 | 16 | 2.400 | 5 | 232501 | | |
| | 40 | 8 | 1.050 | 1.950 - 2.400 | 16 | 2.400 | 5 | 232012 | | |
| | | 10 | 1.050 | 1.950 - 2.400 | 16 | 2.400 | 5 | 232502 | | |
| | 45 | 8 | 1.050 | 1.950 - 2.400 | 16 | 2.400 | 5 | 232013 | | |
| | | 10 | 1.050 | 1.950 - 2.400 | 16 | 2.400 | 5 | 232503 | | |
| | 50 | 8 | 1.050 | 1.950 - 2.400 | 16 | 2.400 | 5 | 232014 | | |
| | | 10 | 1.050 | 1.950 - 2.400 | 16 | 2.400 | 5 | 232504 | | |
| | 55 | 8 | 1.050 | 1.950 - 2.400 | 16 | 2.400 | 5 | 232015 | | |
| | | 10 | 1.050 | 1.950 - 2.400 | 16 | 2.400 | 5 | 232505 | | |
| | 60 | 8 | 1.050 | 1.950 - 2.400 | 16 | 2.400 | 5 | 232016 | | |
| | | 10 | 1.050 | 1.950 - 2.400 | 16 | 2.400 | 5 | 232506 | | |
| | 65 | 8 | 1.050 | 1.950 - 2.400 | 16 | 2.400 | 5 | 232017 | | |
| | | 10 | 1.050 | 1.950 - 2.400 | 16 | 2.400 | 5 | 232507 | | |

233055

| 1.2.2 Дверной замок G-TS PT с 2 крюками и 2 i.S. цапфами Штульп F-16 | | | | | | | L | | № | € |
|--|----|----|-------|---------------|---------------|-------|-------|--------|--------|---|
| удлин. | 92 | 28 | 8 | 1.050 | 1.950 - 2.400 | 16 | 2.400 | 5 | 233050 | |
| | | 10 | 1.050 | 1.950 - 2.400 | 16 | 2.400 | 5 | 233170 | | |
| | 35 | 8 | 1.050 | 1.950 - 2.400 | 16 | 2.400 | 5 | 233051 | | |
| | | 10 | 1.050 | 1.950 - 2.400 | 16 | 2.400 | 5 | 233171 | | |
| | 40 | 8 | 1.050 | 1.950 - 2.400 | 16 | 2.400 | 5 | 233052 | | |
| | | 10 | 1.050 | 1.950 - 2.400 | 16 | 2.400 | 5 | 233172 | | |
| | 45 | 8 | 1.050 | 1.950 - 2.400 | 16 | 2.400 | 5 | 233053 | | |
| | | 10 | 1.050 | 1.950 - 2.400 | 16 | 2.400 | 5 | 233173 | | |
| | 50 | 8 | 1.050 | 1.950 - 2.400 | 16 | 2.400 | 5 | 233054 | | |
| | | 10 | 1.050 | 1.950 - 2.400 | 16 | 2.400 | 5 | 233174 | | |
| | 55 | 8 | 1.050 | 1.950 - 2.400 | 16 | 2.400 | 5 | 233055 | | |
| | | 10 | 1.050 | 1.950 - 2.400 | 16 | 2.400 | 5 | 233175 | | |
| | 60 | 8 | 1.050 | 1.950 - 2.400 | 16 | 2.400 | 5 | 233056 | | |
| | | 10 | 1.050 | 1.950 - 2.400 | 16 | 2.400 | 5 | 233176 | | |
| | 65 | 8 | 1.050 | 1.950 - 2.400 | 16 | 2.400 | 5 | 233057 | | |
| | | 10 | 1.050 | 1.950 - 2.400 | 16 | 2.400 | 5 | 233177 | | |







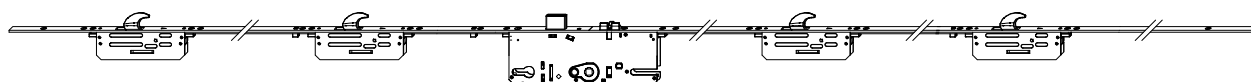

233195

| 1.2.3 Дверной замок G-TS PT с 2 крюками Штульп F-16, не удлиняемый | |  |  |  |  |  |  | L |  | № | € |
|--|----|---|---|---|---|--|---|--------|---|---|---|
| не удли. | 92 | 28 | 8 | 1.050 | 1.900 - 2.400 | 16 | 2.400 | 5 | 233070 | | |
| | | | 10 | 1.050 | 1.900 - 2.400 | 16 | 2.400 | 5 | 233190 | | |
| | 35 | 8 | 1.050 | 1.900 - 2.400 | 16 | 2.400 | 5 | 233071 | | | |
| | | 10 | 1.050 | 1.900 - 2.400 | 16 | 2.400 | 5 | 233191 | | | |
| | 40 | 8 | 1.050 | 1.900 - 2.400 | 16 | 2.400 | 5 | 233072 | | | |
| | | 10 | 1.050 | 1.900 - 2.400 | 16 | 2.400 | 5 | 233192 | | | |
| | 45 | 8 | 1.050 | 1.900 - 2.400 | 16 | 2.400 | 5 | 233073 | | | |
| | | 10 | 1.050 | 1.900 - 2.400 | 16 | 2.400 | 5 | 233193 | | | |
| | 50 | 8 | 1.050 | 1.900 - 2.400 | 16 | 2.400 | 5 | 233074 | | | |
| | | 10 | 1.050 | 1.900 - 2.400 | 16 | 2.400 | 5 | 233194 | | | |
| | 55 | 8 | 1.050 | 1.900 - 2.400 | 16 | 2.400 | 5 | 233075 | | | |
| | | 10 | 1.050 | 1.900 - 2.400 | 16 | 2.400 | 5 | 233195 | | | |
| | 60 | 8 | 1.050 | 1.900 - 2.400 | 16 | 2.400 | 5 | 233076 | | | |
| | | 10 | 1.050 | 1.900 - 2.400 | 16 | 2.400 | 5 | 233196 | | | |
| | 65 | 8 | 1.050 | 1.900 - 2.400 | 16 | 2.400 | 5 | 233077 | | | |
| | | 10 | 1.050 | 1.900 - 2.400 | 16 | 2.400 | 5 | 233197 | | | |



233065

| 1.2.4 Дверной замок G-TS PT с 4 крюками Штульп F-16 | |  |  |  |  |  |  | L |  | № | € |
|---|----|---|---|---|---|--|---|--------|---|---|---|
| не удли. | 92 | 28 | 8 | 1.050 | 1.900 - 2.400 | 16 | 2.400 | 5 | 233060 | | |
| | | | 10 | 1.050 | 1.900 - 2.400 | 16 | 2.400 | 5 | 233180 | | |
| | 35 | 8 | 1.050 | 1.900 - 2.400 | 16 | 2.400 | 5 | 233061 | | | |
| | | 10 | 1.050 | 1.900 - 2.400 | 16 | 2.400 | 5 | 233181 | | | |
| | 40 | 8 | 1.050 | 1.900 - 2.400 | 16 | 2.400 | 5 | 233062 | | | |
| | | 10 | 1.050 | 1.900 - 2.400 | 16 | 2.400 | 5 | 233182 | | | |
| | 45 | 8 | 1.050 | 1.900 - 2.400 | 16 | 2.400 | 5 | 233063 | | | |
| | | 10 | 1.050 | 1.900 - 2.400 | 16 | 2.400 | 5 | 233183 | | | |
| | 50 | 8 | 1.050 | 1.900 - 2.400 | 16 | 2.400 | 5 | 233064 | | | |
| | | 10 | 1.050 | 1.900 - 2.400 | 16 | 2.400 | 5 | 233184 | | | |
| | 55 | 8 | 1.050 | 1.900 - 2.400 | 16 | 2.400 | 5 | 233065 | | | |
| | | 10 | 1.050 | 1.900 - 2.400 | 16 | 2.400 | 5 | 233185 | | | |
| | 60 | 8 | 1.050 | 1.900 - 2.400 | 16 | 2.400 | 5 | 233066 | | | |
| | | 10 | 1.050 | 1.900 - 2.400 | 16 | 2.400 | 5 | 233186 | | | |
| | 65 | 8 | 1.050 | 1.900 - 2.400 | 16 | 2.400 | 5 | 233067 | | | |
| | | 10 | 1.050 | 1.900 - 2.400 | 16 | 2.400 | 5 | 233187 | | | |

232035

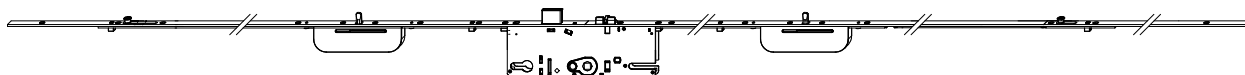

| 1.2.5 | Дверной замок G-TS PT с 2 штырями и 2 i.S. цапфами Штульп F-16 | | | | | | | | | № | € |
|--------|--|----|----|-------|---------------|----|-------|---|--------|---|---|
| удлин. | 92 | 28 | 8 | 1.050 | 1.950 - 2.400 | 16 | 2.400 | 5 | | | |
| | | | 10 | 1.050 | 1.950 - 2.400 | 16 | 2.400 | 5 | 232030 | | |
| | | 35 | 8 | 1.050 | 1.950 - 2.400 | 16 | 2.400 | 5 | 232031 | | |
| | | | 10 | 1.050 | 1.950 - 2.400 | 16 | 2.400 | 5 | 232511 | | |
| | | 40 | 8 | 1.050 | 1.950 - 2.400 | 16 | 2.400 | 5 | 232032 | | |
| | | | 10 | 1.050 | 1.950 - 2.400 | 16 | 2.400 | 5 | 232512 | | |
| | | 45 | 8 | 1.050 | 1.950 - 2.400 | 16 | 2.400 | 5 | 232033 | | |
| | | | 10 | 1.050 | 1.950 - 2.400 | 16 | 2.400 | 5 | 232513 | | |
| | | 50 | 8 | 1.050 | 1.950 - 2.400 | 16 | 2.400 | 5 | 232034 | | |
| | | | 10 | 1.050 | 1.950 - 2.400 | 16 | 2.400 | 5 | 232514 | | |
| | | 55 | 8 | 1.050 | 1.950 - 2.400 | 16 | 2.400 | 5 | 232035 | | |
| | | | 10 | 1.050 | 1.950 - 2.400 | 16 | 2.400 | 5 | 232515 | | |
| | | 60 | 8 | 1.050 | 1.950 - 2.400 | 16 | 2.400 | 5 | 232036 | | |
| | | | 10 | 1.050 | 1.950 - 2.400 | 16 | 2.400 | 5 | 232516 | | |
| | | 65 | 8 | 1.050 | 1.950 - 2.400 | 16 | 2.400 | 5 | 232037 | | |
| | | | 10 | 1.050 | 1.950 - 2.400 | 16 | 2.400 | 5 | 232517 | | |



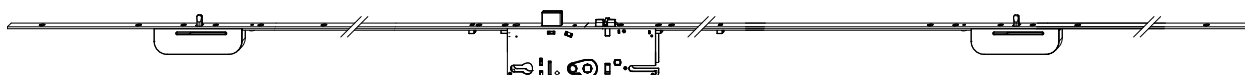





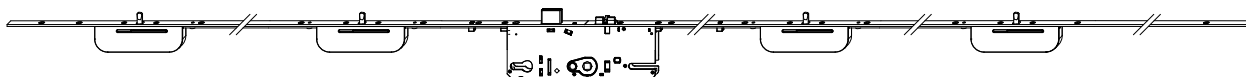



232075



| 1.2.6 | Дверной замок G-TS PT с 2 штырями Штульп F-16, не удлиняемый | | | | | | | | | № | € |
|-----------|--|----|----|-------|---------------|----|-------|---|--------|---|---|
| не удлин. | 92 | 28 | 8 | 1.050 | 1.900 - 2.400 | 16 | 2.400 | 5 | | | |
| | | | 10 | 1.050 | 1.900 - 2.400 | 16 | 2.400 | 5 | 232070 | | |
| | | 35 | 8 | 1.050 | 1.900 - 2.400 | 16 | 2.400 | 5 | 232530 | | |
| | | | 10 | 1.050 | 1.900 - 2.400 | 16 | 2.400 | 5 | 232071 | | |
| | | | 10 | 1.050 | 1.900 - 2.400 | 16 | 2.400 | 5 | 232531 | | |
| | | 40 | 8 | 1.050 | 1.900 - 2.400 | 16 | 2.400 | 5 | 232072 | | |
| | | | 10 | 1.050 | 1.900 - 2.400 | 16 | 2.400 | 5 | 232532 | | |
| | | 45 | 8 | 1.050 | 1.900 - 2.400 | 16 | 2.400 | 5 | 232073 | | |
| | | | 10 | 1.050 | 1.900 - 2.400 | 16 | 2.400 | 5 | 232533 | | |
| | | 50 | 8 | 1.050 | 1.900 - 2.400 | 16 | 2.400 | 5 | 232074 | | |
| | | | 10 | 1.050 | 1.900 - 2.400 | 16 | 2.400 | 5 | 232534 | | |
| | | 55 | 8 | 1.050 | 1.900 - 2.400 | 16 | 2.400 | 5 | 232075 | | |
| | | | 10 | 1.050 | 1.900 - 2.400 | 16 | 2.400 | 5 | 232535 | | |
| | | 60 | 8 | 1.050 | 1.900 - 2.400 | 16 | 2.400 | 5 | 232076 | | |
| | | | 10 | 1.050 | 1.900 - 2.400 | 16 | 2.400 | 5 | 232536 | | |
| | | 65 | 8 | 1.050 | 1.900 - 2.400 | 16 | 2.400 | 5 | 232077 | | |
| | | | 10 | 1.050 | 1.900 - 2.400 | 16 | 2.400 | 5 | 232537 | | |









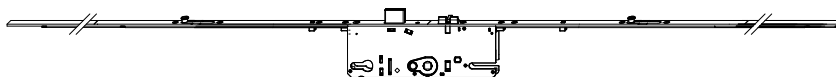



232055



| 1.2.7 Дверной замок G-TS PT с 4 штырями Штульп F-16 | |  |  |  |  |  |  |  |  |  |  |  |  |  |
|---|----|---|---|---|---|---|--|---|---|---|---|---|---|---|
| не удлин. | 92 | 28 | 8 | 1.050 | 1.900 - 2.400 | 16 | 2.400 | 5 | | | | | | |
| | | | | 10 | 1.050 | 1.900 - 2.400 | 16 | 2.400 | 5 | | | | | |
| | | 35 | 8 | 1.050 | 1.900 - 2.400 | 16 | 2.400 | 5 | | | | | | |
| | | | | 10 | 1.050 | 1.900 - 2.400 | 16 | 2.400 | 5 | | | | | |
| | | 40 | 8 | 1.050 | 1.900 - 2.400 | 16 | 2.400 | 5 | | | | | | |
| | | | | 10 | 1.050 | 1.900 - 2.400 | 16 | 2.400 | 5 | | | | | |
| | | 45 | 8 | 1.050 | 1.900 - 2.400 | 16 | 2.400 | 5 | | | | | | |
| | | | | 10 | 1.050 | 1.900 - 2.400 | 16 | 2.400 | 5 | | | | | |
| | | 50 | 8 | 1.050 | 1.900 - 2.400 | 16 | 2.400 | 5 | | | | | | |
| | | | | 10 | 1.050 | 1.900 - 2.400 | 16 | 2.400 | 5 | | | | | |
| | | 55 | 8 | 1.050 | 1.900 - 2.400 | 16 | 2.400 | 5 | | | | | | |
| | | | | 10 | 1.050 | 1.900 - 2.400 | 16 | 2.400 | 5 | | | | | |
| | | 60 | 8 | 1.050 | 1.900 - 2.400 | 16 | 2.400 | 5 | | | | | | |
| | | | | 10 | 1.050 | 1.900 - 2.400 | 16 | 2.400 | 5 | | | | | |
| | | 65 | 8 | 1.050 | 1.900 - 2.400 | 16 | 2.400 | 5 | | | | | | |
| | | | | 10 | 1.050 | 1.900 - 2.400 | 16 | 2.400 | 5 | | | | | |

232145



| 1.2.8 Дверной замок G-TS PT с 2 i.S. цапфами Штульп F-16 | |  |  |  |  |  |  |  |  |  |  |  |  |  |
|--|----|---|---|---|---|---|--|---|---|---|---|---|---|---|
| удлин. | 92 | 28 | 8 | 1.050 | 1.900 - 2.500 | 16 | 1.500 | 5 | | | | | | |
| | | | | 10 | 1.050 | 1.900 - 2.500 | 16 | 1.500 | 5 | | | | | |
| | | 35 | 8 | 1.050 | 1.900 - 2.500 | 16 | 1.500 | 5 | | | | | | |
| | | | | 10 | 1.050 | 1.900 - 2.500 | 16 | 1.500 | 5 | | | | | |
| | | 40 | 8 | 1.050 | 1.900 - 2.500 | 16 | 1.500 | 5 | | | | | | |
| | | | | 10 | 1.050 | 1.900 - 2.500 | 16 | 1.500 | 5 | | | | | |
| | | 45 | 8 | 1.050 | 1.900 - 2.500 | 16 | 1.500 | 5 | | | | | | |
| | | | | 10 | 1.050 | 1.900 - 2.500 | 16 | 1.500 | 5 | | | | | |
| | | 50 | 8 | 1.050 | 1.900 - 2.500 | 16 | 1.500 | 5 | | | | | | |
| | | | | 10 | 1.050 | 1.900 - 2.500 | 16 | 1.500 | 5 | | | | | |
| | | 55 | 8 | 1.050 | 1.900 - 2.500 | 16 | 1.500 | 5 | | | | | | |
| | | | | 10 | 1.050 | 1.900 - 2.500 | 16 | 1.500 | 5 | | | | | |
| | | 60 | 8 | 1.050 | 1.900 - 2.500 | 16 | 1.500 | 5 | | | | | | |
| | | | | 10 | 1.050 | 1.900 - 2.500 | 16 | 1.500 | 5 | | | | | |
| | | 65 | 8 | 1.050 | 1.900 - 2.500 | 16 | 1.500 | 5 | | | | | | |
| | | | | 10 | 1.050 | 1.900 - 2.500 | 16 | 1.500 | 5 | | | | | |

233514



| 1.2.9 Дверной замок G-TS PT с 2 крюками Штульп F-16, 2-створч. | | | | | | | L | | № | € |
|--|----|----|-------|---------------|---------------|-------|-------|--------|--------|---|
| удлин. | 92 | 28 | 8 | 1.050 | 1.900 - 2.500 | 16 | 1.500 | 5 | 233500 | |
| | | 10 | 1.050 | 1.900 - 2.500 | 16 | 1.500 | 5 | 233510 | | |
| | 35 | 8 | 1.050 | 1.900 - 2.500 | 16 | 1.500 | 5 | 233501 | | |
| | | 10 | 1.050 | 1.900 - 2.500 | 16 | 1.500 | 5 | 233511 | | |
| | 40 | 8 | 1.050 | 1.900 - 2.500 | 16 | 1.500 | 5 | 233502 | | |
| | | 10 | 1.050 | 1.900 - 2.500 | 16 | 1.500 | 5 | 233512 | | |
| | 45 | 8 | 1.050 | 1.900 - 2.500 | 16 | 1.500 | 5 | 233503 | | |
| | | 10 | 1.050 | 1.900 - 2.500 | 16 | 1.500 | 5 | 233513 | | |
| | 50 | 8 | 1.050 | 1.900 - 2.500 | 16 | 1.500 | 5 | 233504 | | |
| | | 10 | 1.050 | 1.900 - 2.500 | 16 | 1.500 | 5 | 233514 | | |
| | 55 | 8 | 1.050 | 1.900 - 2.500 | 16 | 1.500 | 5 | 233505 | | |
| | | 10 | 1.050 | 1.900 - 2.500 | 16 | 1.500 | 5 | 233515 | | |
| | 60 | 8 | 1.050 | 1.900 - 2.500 | 16 | 1.500 | 5 | 233506 | | |
| | | 10 | 1.050 | 1.900 - 2.500 | 16 | 1.500 | 5 | 233516 | | |
| | 65 | 8 | 1.050 | 1.900 - 2.500 | 16 | 1.500 | 5 | 233507 | | |
| | | 10 | 1.050 | 1.900 - 2.500 | 16 | 1.500 | 5 | 233517 | | |

232155



| 1.2.10 Дверной замок G-TS PT с 2 штырями Штульп F-16, 2-створч. | | | | | | | L | | № | € |
|---|----|----|-------|---------------|---------------|-------|-------|--------|--------|---|
| удлин. | 92 | 28 | 8 | 1.050 | 1.900 - 2.500 | 16 | 1.500 | 5 | 232150 | |
| | | 10 | 1.050 | 1.900 - 2.500 | 16 | 1.500 | 5 | 232180 | | |
| | 35 | 8 | 1.050 | 1.900 - 2.500 | 16 | 1.500 | 5 | 232151 | | |
| | | 10 | 1.050 | 1.900 - 2.500 | 16 | 1.500 | 5 | 232181 | | |
| | 40 | 8 | 1.050 | 1.900 - 2.500 | 16 | 1.500 | 5 | 232152 | | |
| | | 10 | 1.050 | 1.900 - 2.500 | 16 | 1.500 | 5 | 232182 | | |
| | 45 | 8 | 1.050 | 1.900 - 2.500 | 16 | 1.500 | 5 | 232153 | | |
| | | 10 | 1.050 | 1.900 - 2.500 | 16 | 1.500 | 5 | 232183 | | |
| | 50 | 8 | 1.050 | 1.900 - 2.500 | 16 | 1.500 | 5 | 232154 | | |
| | | 10 | 1.050 | 1.900 - 2.500 | 16 | 1.500 | 5 | 232184 | | |
| | 55 | 8 | 1.050 | 1.900 - 2.500 | 16 | 1.500 | 5 | 232155 | | |
| | | 10 | 1.050 | 1.900 - 2.500 | 16 | 1.500 | 5 | 232185 | | |
| | 60 | 8 | 1.050 | 1.900 - 2.400 | 16 | 1.500 | 5 | 232156 | | |
| | | 10 | 1.050 | 1.900 - 2.500 | 16 | 1.500 | 5 | 232186 | | |
| | 65 | 8 | 1.050 | 1.900 - 2.500 | 16 | 1.500 | 5 | 232157 | | |
| | | 10 | 1.050 | 1.900 - 2.500 | 16 | 1.500 | 5 | 232187 | | |













233485











| 1.2.11 Дверной замок G-TS PT без i.S. цапф Штульп F-16 | | | | | | | | L | | № | € |
|---|----|----|-------|---------------|---------------|-------|-------|---------------|---------------|----------|----------|
| удлин. | 92 | 28 | 8 | 1.050 | 1.900 - 2.500 | 16 | 1.500 | 5 | 233480 | | |
| | | | 10 | 1.050 | 1.900 - 2.500 | 16 | 1.500 | 5 | 233490 | | |
| | 35 | 8 | 1.050 | 1.900 - 2.500 | 16 | 1.500 | 5 | 233481 | | | |
| | | 10 | 1.050 | 1.900 - 2.500 | 16 | 1.500 | 5 | 233491 | | | |
| | 40 | 8 | 1.050 | 1.900 - 2.500 | 16 | 1.500 | 5 | 233482 | | | |
| | | 10 | 1.050 | 1.900 - 2.500 | 16 | 1.500 | 5 | 233492 | | | |
| | 45 | 8 | 1.050 | 1.900 - 2.500 | 16 | 1.500 | 5 | 233483 | | | |
| | | 10 | 1.050 | 1.900 - 2.500 | 16 | 1.500 | 5 | 233493 | | | |
| | 50 | 8 | 1.050 | 1.900 - 2.500 | 16 | 1.500 | 5 | 233484 | | | |
| | | 10 | 1.050 | 1.900 - 2.500 | 16 | 1.500 | 5 | 233494 | | | |
| | 55 | 8 | 1.050 | 1.900 - 2.500 | 16 | 1.500 | 5 | 233485 | | | |
| | | 10 | 1.050 | 1.900 - 2.500 | 16 | 1.500 | 5 | 233495 | | | |
| | 60 | 8 | 1.050 | 1.900 - 2.500 | 16 | 1.500 | 5 | 233486 | | | |
| | | 10 | 1.050 | 1.900 - 2.500 | 16 | 1.500 | 5 | 233496 | | | |
| | 65 | 8 | 1.050 | 1.900 - 2.500 | 16 | 1.500 | 5 | 233487 | | | |
| | | 10 | 1.050 | 1.900 - 2.500 | 16 | 1.500 | 5 | 233497 | | | |

1.3 E92 Штульп F-20

232215

| 1.3.1 Дверной замок G-TS PT с 4 i.S. цапфами Штульп F-20 | |  |  |  |  |  |  |  |  |  |  | № | € | |
|--|----|---|---|---|---|---|--|---|---|---|---|---|---|--|
| удлин. | 92 | 28 | 8 | 1.050 | 1.950 - 2.400 | 20 | 2.400 | 5 | 232210 | | | | | |
| | | 10 | 1.050 | 1.950 - 2.400 | 20 | 2.400 | 5 | 232570 | | | | | | |
| | 35 | 8 | 1.050 | 1.950 - 2.400 | 20 | 2.400 | 5 | 232211 | | | | | | |
| | | 10 | 1.050 | 1.950 - 2.400 | 20 | 2.400 | 5 | 232571 | | | | | | |
| | 40 | 8 | 1.050 | 1.950 - 2.400 | 20 | 2.400 | 5 | 232212 | | | | | | |
| | | 10 | 1.050 | 1.950 - 2.400 | 20 | 2.400 | 5 | 232572 | | | | | | |
| | 45 | 8 | 1.050 | 1.950 - 2.400 | 20 | 2.400 | 5 | 232213 | | | | | | |
| | | 10 | 1.050 | 1.950 - 2.400 | 20 | 2.400 | 5 | 232573 | | | | | | |
| | 50 | 8 | 1.050 | 1.950 - 2.400 | 20 | 2.400 | 5 | 232214 | | | | | | |
| | | 10 | 1.050 | 1.950 - 2.400 | 20 | 2.400 | 5 | 232574 | | | | | | |
| | 55 | 8 | 1.050 | 1.950 - 2.400 | 20 | 2.400 | 5 | 232215 | | | | | | |
| | | 10 | 1.050 | 1.950 - 2.400 | 20 | 2.400 | 5 | 232575 | | | | | | |
| | 60 | 8 | 1.050 | 1.950 - 2.400 | 20 | 2.400 | 5 | 232216 | | | | | | |
| | | 10 | 1.050 | 1.950 - 2.400 | 20 | 2.400 | 5 | 232576 | | | | | | |
| | 65 | 8 | 1.050 | 1.950 - 2.400 | 20 | 2.400 | 5 | 232217 | | | | | | |
| | | 10 | 1.050 | 1.950 - 2.400 | 20 | 2.400 | 5 | 232577 | | | | | | |

233095

| 1.3.2 Дверной замок G-TS PT с 2 крюками и 2 i.S. цапфами Штульп F-20 | |  |  |  |  |  |  |  |  |  |  | № | € |
|--|----|---|---|---|---|---|--|---|---|---|---|---|---|
| удлин. | 92 | 28 | 8 | 1.050 | 1.950 - 2.400 | 20 | 2.400 | 5 | 233090 | | | | |
| | | 10 | 1.050 | 1.950 - 2.400 | 20 | 2.400 | 5 | 233210 | | | | | |
| | 35 | 8 | 1.050 | 1.950 - 2.400 | 20 | 2.400 | 5 | 233091 | | | | | |
| | | 10 | 1.050 | 1.950 - 2.400 | 20 | 2.400 | 5 | 233211 | | | | | |
| | 40 | 8 | 1.050 | 1.950 - 2.400 | 20 | 2.400 | 5 | 233092 | | | | | |
| | | 10 | 1.050 | 1.950 - 2.400 | 20 | 2.400 | 5 | 233212 | | | | | |
| | 45 | 8 | 1.050 | 1.950 - 2.400 | 20 | 2.400 | 5 | 233093 | | | | | |
| | | 10 | 1.050 | 1.950 - 2.400 | 20 | 2.400 | 5 | 233213 | | | | | |
| | 50 | 8 | 1.050 | 1.950 - 2.400 | 20 | 2.400 | 5 | 233094 | | | | | |
| | | 10 | 1.050 | 1.950 - 2.400 | 20 | 2.400 | 5 | 233214 | | | | | |
| | 55 | 8 | 1.050 | 1.950 - 2.400 | 20 | 2.400 | 5 | 233095 | | | | | |
| | | 10 | 1.050 | 1.950 - 2.400 | 20 | 2.400 | 5 | 233215 | | | | | |
| | 60 | 8 | 1.050 | 1.950 - 2.400 | 20 | 2.400 | 5 | 233096 | | | | | |
| | | 10 | 1.050 | 1.950 - 2.400 | 20 | 2.400 | 5 | 233216 | | | | | |
| | 65 | 8 | 1.050 | 1.950 - 2.400 | 20 | 2.400 | 5 | 233097 | | | | | |
| | | 10 | 1.050 | 1.950 - 2.400 | 20 | 2.400 | 5 | 233217 | | | | | |

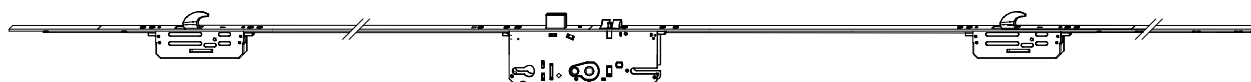

233235

| 1.3.3 Дверной замок G-TS PT с 2 крюками Штульп F-20 | | | | | | | | | | | № | € |
|---|----|----|-------|---------------|---------------|-------|-------|---|--|--------|--------|---|
| не удлин. | 92 | 28 | 8 | 1.050 | 1.900 - 2.400 | 20 | 2.400 | 5 | | | 233110 | |
| | | | 10 | 1.050 | 1.900 - 2.400 | 20 | 2.400 | 5 | | | 233230 | |
| | 35 | 8 | 1.050 | 1.900 - 2.400 | 20 | 2.400 | 5 | | | 233111 | | |
| | | 10 | 1.050 | 1.900 - 2.400 | 20 | 2.400 | 5 | | | 233231 | | |
| | 40 | 8 | 1.050 | 1.900 - 2.400 | 20 | 2.400 | 5 | | | 233112 | | |
| | | 10 | 1.050 | 1.900 - 2.400 | 20 | 2.400 | 5 | | | 233232 | | |
| | 45 | 8 | 1.050 | 1.900 - 2.400 | 20 | 2.400 | 5 | | | 233113 | | |
| | | 10 | 1.050 | 1.900 - 2.400 | 20 | 2.400 | 5 | | | 233233 | | |
| | 50 | 8 | 1.050 | 1.900 - 2.400 | 20 | 2.400 | 5 | | | 233114 | | |
| | | 10 | 1.050 | 1.900 - 2.400 | 20 | 2.400 | 5 | | | 233234 | | |
| | 55 | 8 | 1.050 | 1.900 - 2.400 | 20 | 2.400 | 5 | | | 233115 | | |
| | | 10 | 1.050 | 1.900 - 2.400 | 20 | 2.400 | 5 | | | 233235 | | |
| | 60 | 8 | 1.050 | 1.900 - 2.400 | 20 | 2.400 | 5 | | | 233116 | | |
| | | 10 | 1.050 | 1.900 - 2.400 | 20 | 2.400 | 5 | | | 233236 | | |
| | 65 | 8 | 1.050 | 1.900 - 2.400 | 20 | 2.400 | 5 | | | 233117 | | |
| | | 10 | 1.050 | 1.900 - 2.400 | 20 | 2.400 | 5 | | | 233237 | | |

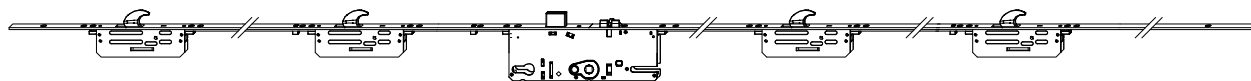





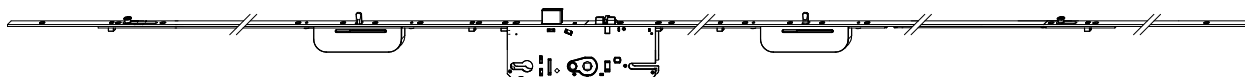

233105

| 1.3.4 Дверной замок G-TS PT с 4 крюками Штульп F-20 | | | | | | | | | | | № | € |
|---|----|----|-------|---------------|---------------|-------|-------|---|--|--------|--------|---|
| не удлин. | 92 | 28 | 8 | 1.050 | 1.900 - 2.400 | 20 | 2.400 | 5 | | | 233100 | |
| | | | 10 | 1.050 | 1.900 - 2.400 | 20 | 2.400 | 5 | | | 233220 | |
| | 35 | 8 | 1.050 | 1.900 - 2.400 | 20 | 2.400 | 5 | | | 233101 | | |
| | | 10 | 1.050 | 1.900 - 2.400 | 20 | 2.400 | 5 | | | 233221 | | |
| | 40 | 8 | 1.050 | 1.900 - 2.400 | 20 | 2.400 | 5 | | | 233102 | | |
| | | 10 | 1.050 | 1.900 - 2.400 | 20 | 2.400 | 5 | | | 233222 | | |
| | 45 | 8 | 1.050 | 1.900 - 2.400 | 20 | 2.400 | 5 | | | 233103 | | |
| | | 10 | 1.050 | 1.900 - 2.400 | 20 | 2.400 | 5 | | | 233223 | | |
| | 50 | 8 | 1.050 | 1.900 - 2.400 | 20 | 2.400 | 5 | | | 233104 | | |
| | | 10 | 1.050 | 1.900 - 2.400 | 20 | 2.400 | 5 | | | 233224 | | |
| | 55 | 8 | 1.050 | 1.900 - 2.400 | 20 | 2.400 | 5 | | | 233105 | | |
| | | 10 | 1.050 | 1.900 - 2.400 | 20 | 2.400 | 5 | | | 233225 | | |
| | 60 | 8 | 1.050 | 1.900 - 2.400 | 20 | 2.400 | 5 | | | 233106 | | |
| | | 10 | 1.050 | 1.900 - 2.400 | 20 | 2.400 | 5 | | | 233226 | | |
| | 65 | 8 | 1.050 | 1.900 - 2.400 | 20 | 2.400 | 5 | | | 233107 | | |
| | | 10 | 1.050 | 1.900 - 2.400 | 20 | 2.400 | 5 | | | 233227 | | |







232235

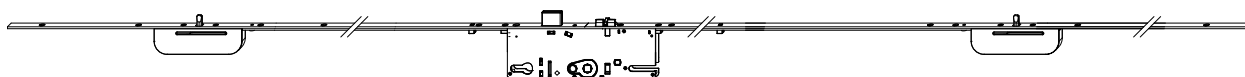

| 1.3.5 Дверной замок G-TS PT с 2 штырями и 2 i.S. цапфами Штульп F-20 | |  |  |  |  |  |  | L |  | № | € |
|--|----|---|---|---|---|---|--|--------|---|---|---|
| удлин. | 92 | 28 | 8 | 1.050 | 1.950 - 2.400 | 20 | 2.400 | 5 | 232230 | | |
| | | 10 | 1.050 | 1.950 - 2.400 | 20 | 2.400 | 5 | 232580 | | | |
| | 35 | 8 | 1.050 | 1.950 - 2.400 | 20 | 2.400 | 5 | 232231 | | | |
| | | 10 | 1.050 | 1.950 - 2.400 | 20 | 2.400 | 5 | 232581 | | | |
| | 40 | 8 | 1.050 | 1.950 - 2.400 | 20 | 2.400 | 5 | 232232 | | | |
| | | 10 | 1.050 | 1.950 - 2.400 | 20 | 2.400 | 5 | 232582 | | | |
| | 45 | 8 | 1.050 | 1.950 - 2.400 | 20 | 2.400 | 5 | 232233 | | | |
| | | 10 | 1.050 | 1.950 - 2.400 | 20 | 2.400 | 5 | 232583 | | | |
| | 50 | 8 | 1.050 | 1.950 - 2.400 | 20 | 2.400 | 5 | 232234 | | | |
| | | 10 | 1.050 | 1.950 - 2.400 | 20 | 2.400 | 5 | 232584 | | | |
| | 55 | 8 | 1.050 | 1.950 - 2.400 | 20 | 2.400 | 5 | 232235 | | | |
| | | 10 | 1.050 | 1.950 - 2.400 | 20 | 2.400 | 5 | 232585 | | | |
| | 60 | 8 | 1.050 | 1.950 - 2.400 | 20 | 2.400 | 5 | 232236 | | | |
| | | 10 | 1.050 | 1.950 - 2.400 | 20 | 2.400 | 5 | 232586 | | | |
| | 65 | 8 | 1.050 | 1.950 - 2.400 | 20 | 2.400 | 5 | 232237 | | | |
| | | 10 | 1.050 | 1.950 - 2.400 | 20 | 2.400 | 5 | 232587 | | | |

232275



| 1.3.6 Дверной замок G-TS PT с 2 штырями Штульп F-20 | |  |  |  |  |  | L |  | № | € |
|---|----|---|---|---|---|---|-------|---|--------|---|
| не удлин. | 92 | 28 | 8 | 1.050 | 1.900 - 2.400 | 20 | 2.400 | 5 | 232270 | |
| | | 10 | 1.050 | 1.900 - 2.400 | 20 | 2.400 | 5 | 232600 | | |
| | 35 | 8 | 1.050 | 1.900 - 2.400 | 20 | 2.400 | 5 | 232271 | | |
| | | 10 | 1.050 | 1.900 - 2.400 | 20 | 2.400 | 5 | 232601 | | |
| | 40 | 8 | 1.050 | 1.900 - 2.400 | 20 | 2.400 | 5 | 232272 | | |
| | | 10 | 1.050 | 1.900 - 2.400 | 20 | 2.400 | 5 | 232602 | | |
| | 45 | 8 | 1.050 | 1.900 - 2.400 | 20 | 2.400 | 5 | 232273 | | |
| | | 10 | 1.050 | 1.900 - 2.400 | 20 | 2.400 | 5 | 232603 | | |
| | 50 | 8 | 1.050 | 1.900 - 2.400 | 20 | 2.400 | 5 | 232274 | | |
| | | 10 | 1.050 | 1.900 - 2.400 | 20 | 2.400 | 5 | 232604 | | |
| | 55 | 8 | 1.050 | 1.900 - 2.400 | 20 | 2.400 | 5 | 232275 | | |
| | | 10 | 1.050 | 1.900 - 2.400 | 20 | 2.400 | 5 | 232605 | | |
| | 60 | 8 | 1.050 | 1.900 - 2.400 | 20 | 2.400 | 5 | 232276 | | |
| | | 10 | 1.050 | 1.900 - 2.400 | 20 | 2.400 | 5 | 232606 | | |
| | 65 | 8 | 1.050 | 1.900 - 2.400 | 20 | 2.400 | 5 | 232277 | | |
| | | 10 | 1.050 | 1.900 - 2.400 | 20 | 2.400 | 5 | 232607 | | |

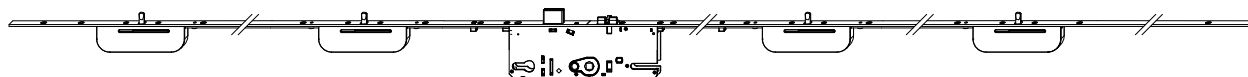

232255

| 1.3.7 Дверной замок G-TS PT с 4 штырями Штульп F-20 | | | | | | | | L | | № | € |
|---|----|----|-------|---------------|---------------|-------|-------|---------------|---------------|----------|----------|
| не удлин. | 92 | 28 | 8 | 1.050 | 1.900 - 2.400 | 20 | 2.400 | 5 | 232250 | | |
| | | 10 | 1.050 | 1.900 - 2.400 | 20 | 2.400 | 5 | 232590 | | | |
| | 35 | 8 | 1.050 | 1.900 - 2.400 | 20 | 2.400 | 5 | 232251 | | | |
| | | 10 | 1.050 | 1.900 - 2.400 | 20 | 2.400 | 5 | 232591 | | | |
| | 40 | 8 | 1.050 | 1.900 - 2.400 | 20 | 2.400 | 5 | 232252 | | | |
| | | 10 | 1.050 | 1.900 - 2.400 | 20 | 2.400 | 5 | 232592 | | | |
| | 45 | 8 | 1.050 | 1.900 - 2.400 | 20 | 2.400 | 5 | 232253 | | | |
| | | 10 | 1.050 | 1.900 - 2.400 | 20 | 2.400 | 5 | 232593 | | | |
| | 50 | 8 | 1.050 | 1.900 - 2.400 | 20 | 2.400 | 5 | 232254 | | | |
| | | 10 | 1.050 | 1.900 - 2.400 | 20 | 2.400 | 5 | 232594 | | | |
| | 55 | 8 | 1.050 | 1.900 - 2.400 | 20 | 2.400 | 5 | 232255 | | | |
| | | 10 | 1.050 | 1.900 - 2.400 | 20 | 2.400 | 5 | 232595 | | | |
| | 60 | 8 | 1.050 | 1.900 - 2.400 | 20 | 2.400 | 5 | 232256 | | | |
| | | 10 | 1.050 | 1.900 - 2.400 | 20 | 2.400 | 5 | 232596 | | | |
| | 65 | 8 | 1.050 | 1.900 - 2.400 | 20 | 2.400 | 5 | 232257 | | | |
| | | 10 | 1.050 | 1.900 - 2.400 | 20 | 2.400 | 5 | 232597 | | | |



2 Дверные замки Z-TS Modul PT

| | | |
|-----|---|----|
| 2.1 | Обзор программы PROTECT Modul | 22 |
| 2.2 | E92 | 27 |
| 2.3 | E92 с дополнительным замком | 43 |
| 2.4 | E88 | 47 |
| 2.5 | Принадлежности для замков Modul | 50 |
| 2.6 | Роликовая защёлка для замка Z-TS PT-M | 53 |
| 2.7 | Сменная фалевая защёлка для замка Z-TS PT-M | 53 |
| 2.8 | Пластиковая клипса фалевой защёлки | 53 |

2 Дверные замки Z-TS Modul PT

2.1 Обзор программы PROTECT Modul

3,1 m

"Модульные" возможности MACO PROTECT MODUL

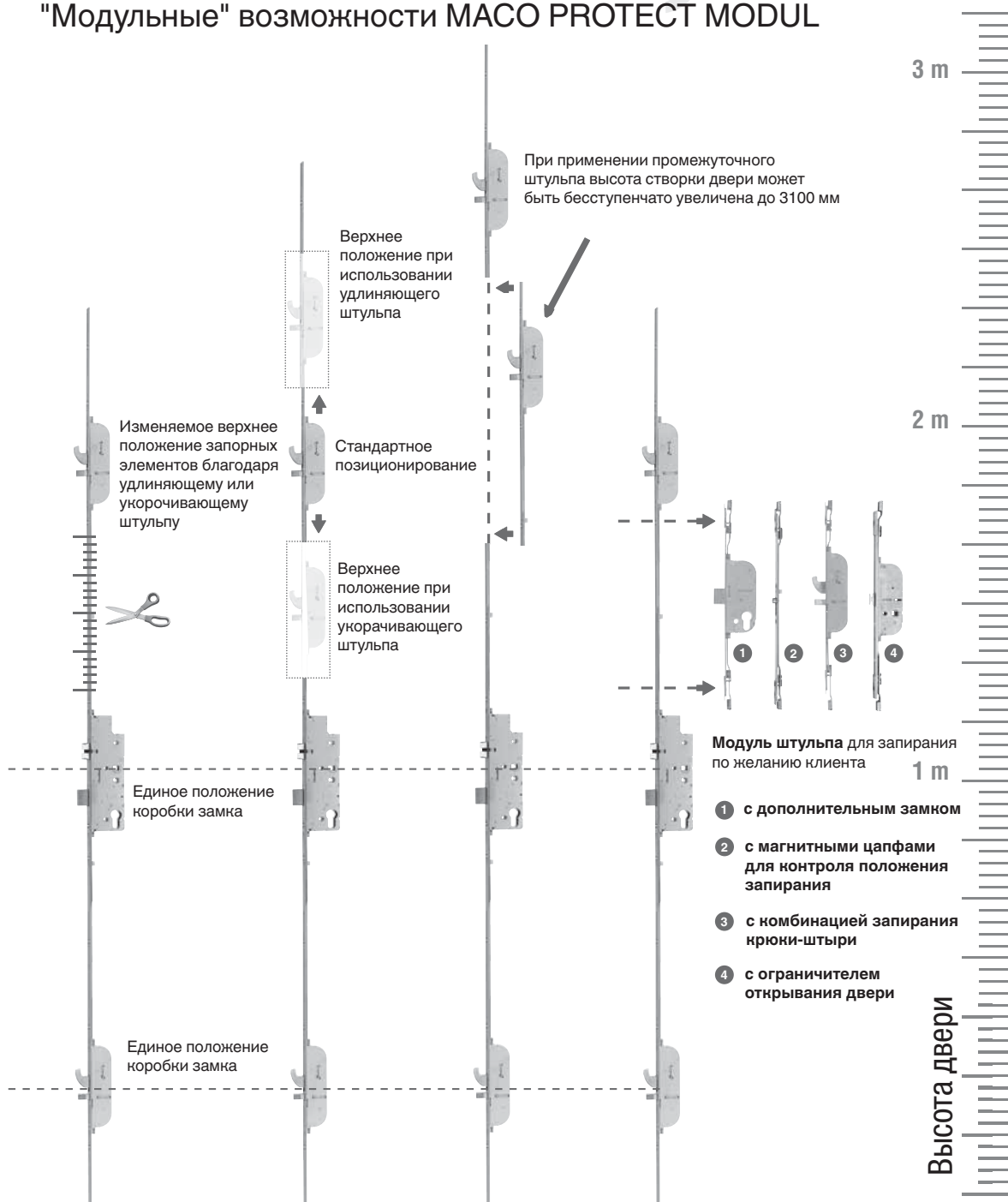

Единое положение
коробки замка

- ① Комбинация из 2-х крюков и 2-х штырей, 2 крюка, 2 штыря
- ② Комбинация из 4-х крюков и 4-х штырей, 4 крюка, 4 штыря
- ③ Комбинация из 2-х крюков и 2-х штырей + дополнительный замок
Комбинация из 2-х крюков + дополнительный замок, 2-х штырей + дополнительный замок

2

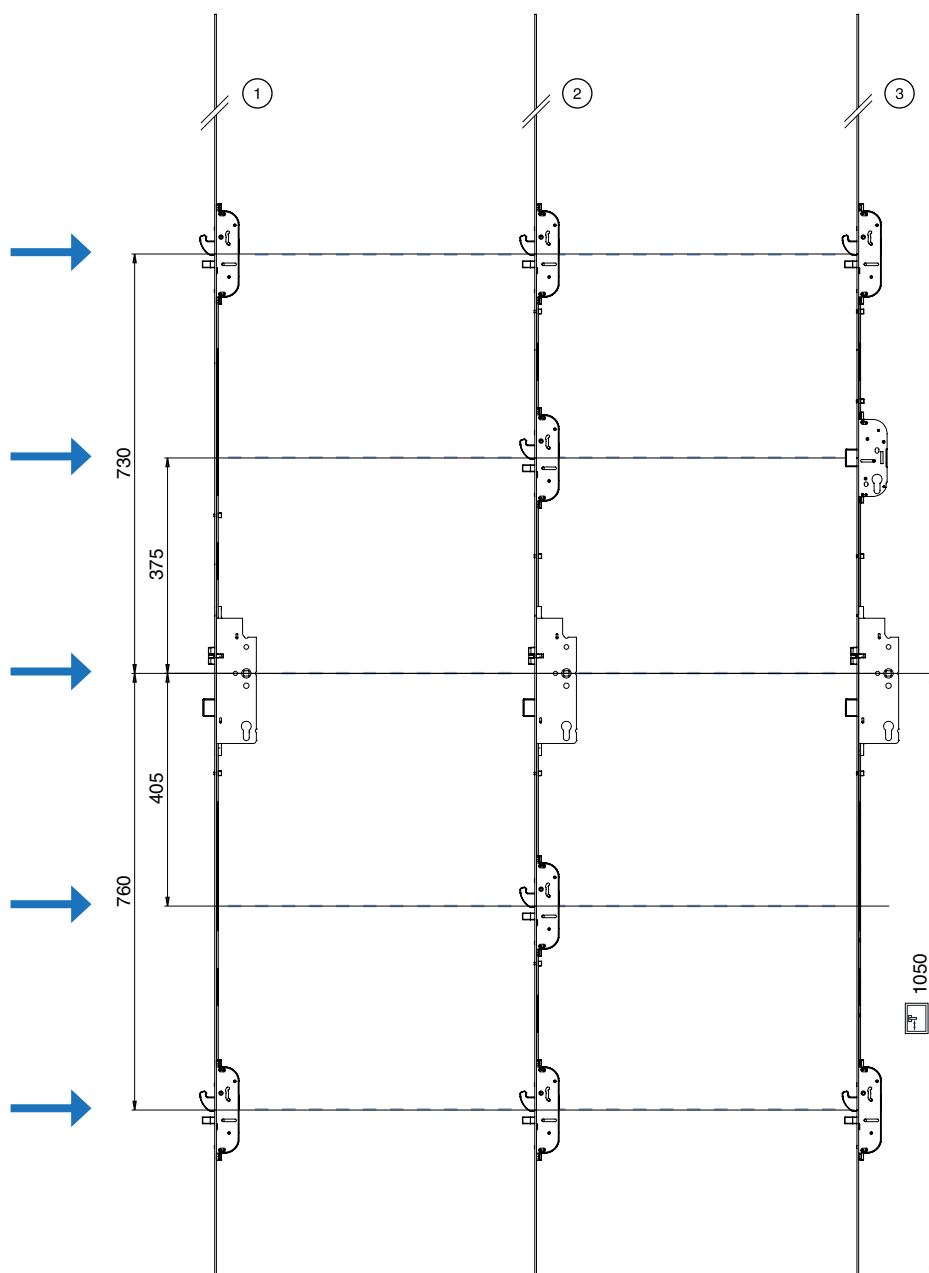

Переменное позиционирование верхней коробки
замки в комбинации крюки-штыри

- ① Стандартный замок
- ② Укорачивающий штульп
- ③ Удлиняющий штульп

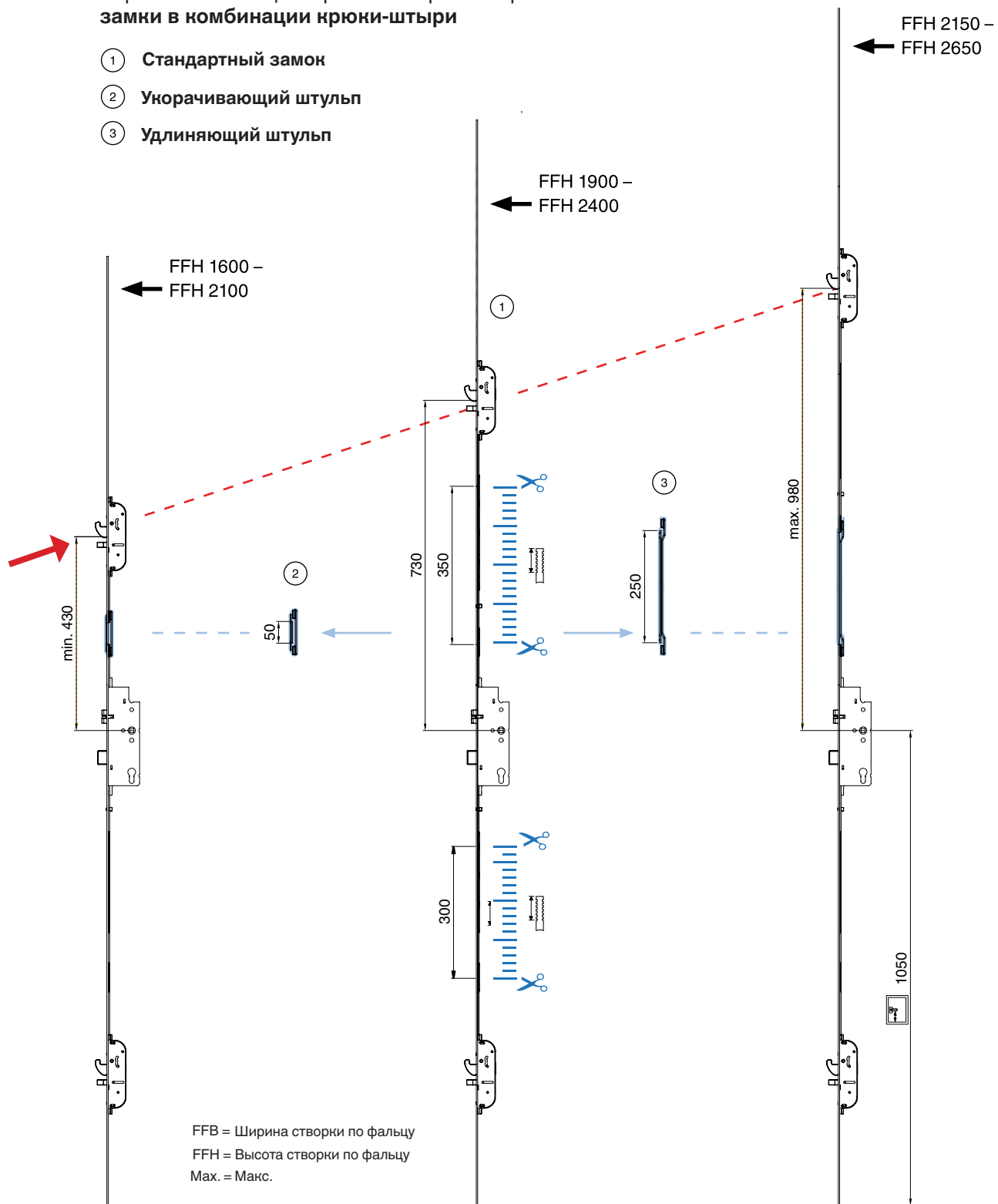

Переменно позиционированный штупль модуля

- ① Стандартный замок
- ② Модуль штупля с дополнительным замком
- ③ Модуль штупля в комбинации крюк-штырь
- ④ Магнитные цапфы

2

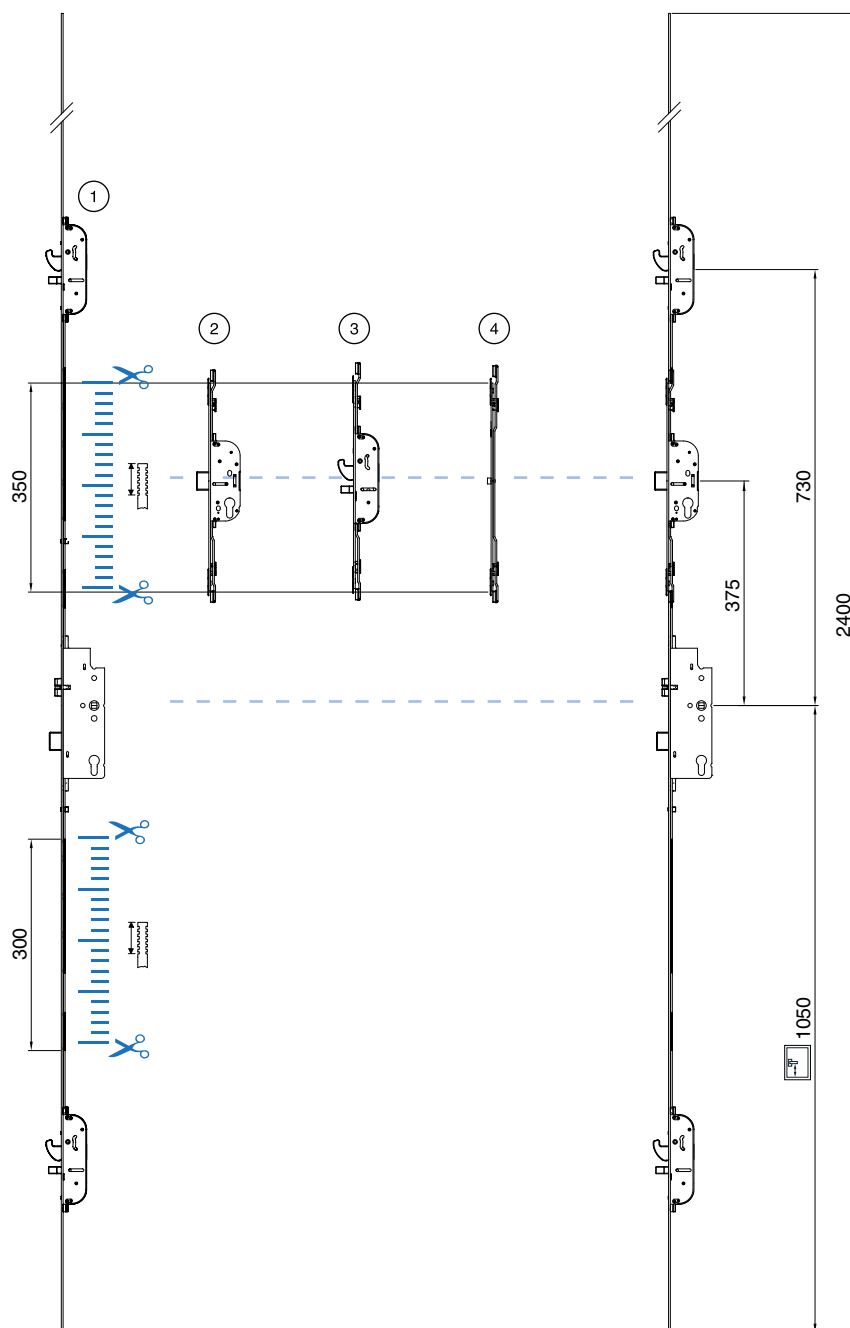

2 крюка-штыря, 2 крюка, 2 штыря

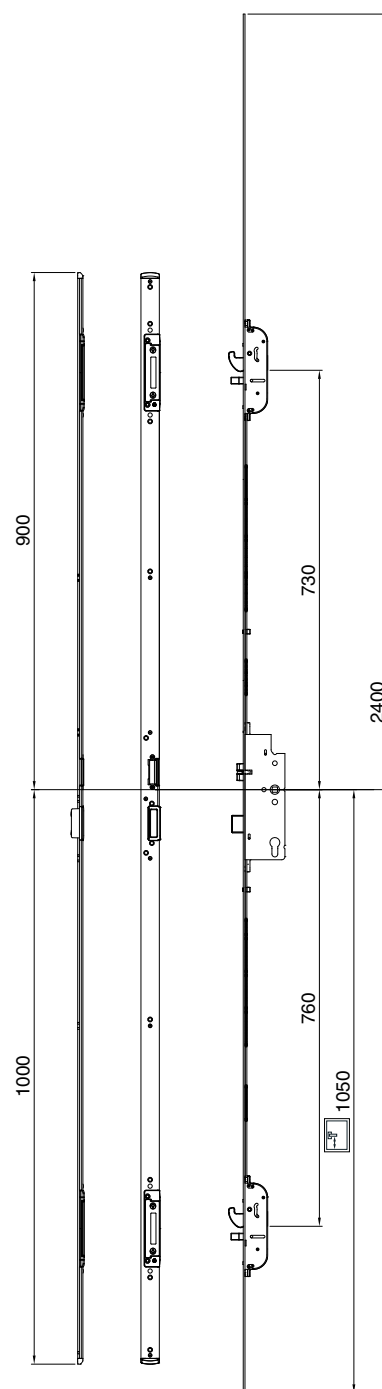
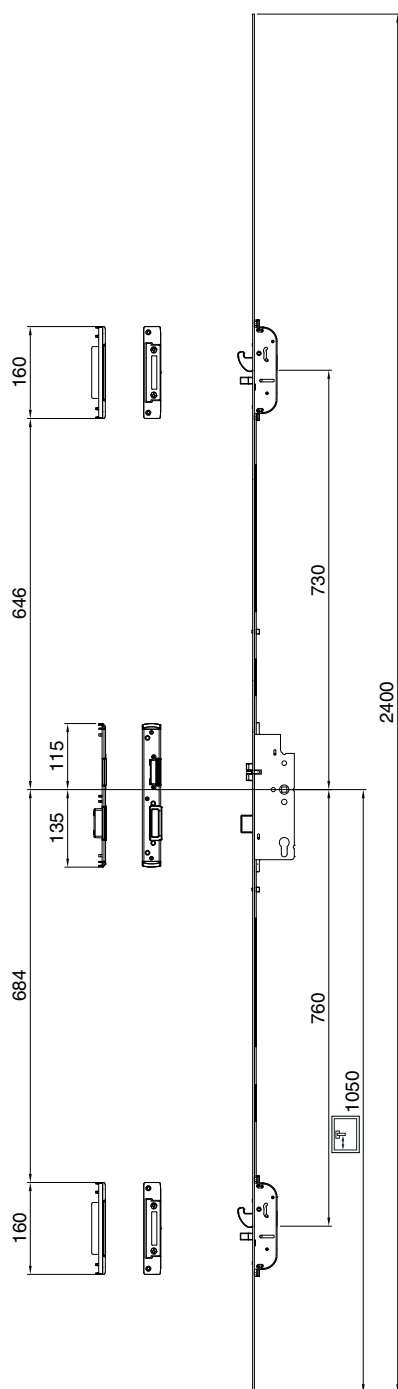

2.2 E92

2.2.1 Штульп F-16

230694

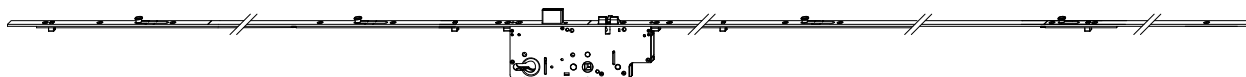

2.2.1.1 Дверной замок Z-TS PT с 4 i.S. цапфами Штульп F-16

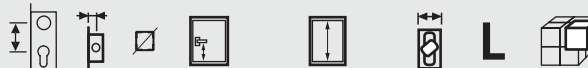

| | 92 | 25 | 8 | 1.050 | 1.950 - 2.400 | 16 | 2.400 | 5 | № | € |
|-------------------|----|----|-------|---------------|---------------|-------|-------|--------|--------|---|
| удлин. без ригеля | | 30 | 8 | 1.050 | 1.950 - 2.400 | 16 | 2.400 | 5 | 234180 | |
| | | 30 | 8 | 1.050 | 1.950 - 2.400 | 16 | 2.400 | 5 | 234181 | |
| удлин. | 92 | 35 | 8 | 1.050 | 1.950 - 2.400 | 16 | 2.400 | 5 | 230690 | |
| | | 10 | 1.050 | 1.950 - 2.400 | 16 | 2.400 | 5 | 230020 | | |
| | 40 | 8 | 1.050 | 1.950 - 2.400 | 16 | 2.400 | 5 | 230691 | | |
| | | 10 | 1.050 | 1.950 - 2.400 | 16 | 2.400 | 5 | 230021 | | |
| | 45 | 8 | 1.050 | 1.950 - 2.400 | 16 | 2.400 | 5 | 230692 | | |
| | | 10 | 1.050 | 1.950 - 2.400 | 16 | 2.400 | 5 | 230022 | | |
| | 50 | 8 | 1.050 | 1.950 - 2.400 | 16 | 2.400 | 5 | 230693 | | |
| | | 10 | 1.050 | 1.950 - 2.400 | 16 | 2.400 | 5 | 230023 | | |
| | 55 | 8 | 1.050 | 1.950 - 2.400 | 16 | 2.400 | 5 | 230694 | | |
| | | 10 | 1.050 | 1.950 - 2.400 | 16 | 2.400 | 5 | 230024 | | |
| | 65 | 8 | 1.050 | 1.950 - 2.400 | 16 | 2.400 | 5 | 230695 | | |
| | | 10 | 1.050 | 1.950 - 2.400 | 16 | 2.400 | 5 | 230025 | | |
| | 70 | 8 | 1.050 | 1.950 - 2.400 | 16 | 2.400 | 5 | 230696 | | |
| | | 10 | 1.050 | 1.950 - 2.400 | 16 | 2.400 | 5 | 230026 | | |
| | 80 | 8 | 1.050 | 1.950 - 2.400 | 16 | 2.400 | 5 | 230697 | | |
| | | 10 | 1.050 | 1.950 - 2.400 | 16 | 2.400 | 5 | 230027 | | |

238564





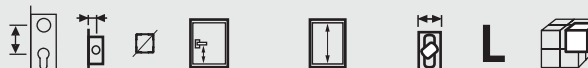







2.2.1.2 Дверной замок Z-TS PT-M с 2 крюками-штырями и 2 i.S. цапфами Штульп F-16



| | 92 | 35 | 8 | 1.050 | 1.950 - 2.400 | 16 | 2.400 | 5 | № | € |
|--------|----|----|-------|---------------|---------------|-------|-------|--------|--------|---|
| модуль | 92 | 35 | 8 | 1.050 | 1.950 - 2.400 | 16 | 2.400 | 5 | 238560 | |
| | | 10 | 1.050 | 1.950 - 2.400 | 16 | 2.400 | 5 | 238570 | | |
| | 40 | 8 | 1.050 | 1.950 - 2.400 | 16 | 2.400 | 5 | 238561 | | |
| | | 10 | 1.050 | 1.950 - 2.400 | 16 | 2.400 | 5 | 238571 | | |
| | 45 | 8 | 1.050 | 1.950 - 2.400 | 16 | 2.400 | 5 | 238562 | | |
| | | 10 | 1.050 | 1.950 - 2.400 | 16 | 2.400 | 5 | 238572 | | |
| | 50 | 8 | 1.050 | 1.950 - 2.400 | 16 | 2.400 | 5 | 238563 | | |
| | | 10 | 1.050 | 1.950 - 2.400 | 16 | 2.400 | 5 | 238573 | | |
| | 55 | 8 | 1.050 | 1.950 - 2.400 | 16 | 2.400 | 5 | 238564 | | |
| | | 10 | 1.050 | 1.950 - 2.400 | 16 | 2.400 | 5 | 238574 | | |
| | 65 | 8 | 1.050 | 1.950 - 2.400 | 16 | 2.400 | 5 | 238565 | | |
| | | 10 | 1.050 | 1.950 - 2.400 | 16 | 2.400 | 5 | 238575 | | |
| | 70 | 8 | 1.050 | 1.950 - 2.400 | 16 | 2.400 | 5 | 238566 | | |
| | | 10 | 1.050 | 1.950 - 2.400 | 16 | 2.400 | 5 | 238576 | | |
| | 80 | 8 | 1.050 | 1.950 - 2.400 | 16 | 2.400 | 5 | 238567 | | |
| | | 10 | 1.050 | 1.950 - 2.400 | 16 | 2.400 | 5 | 238577 | | |







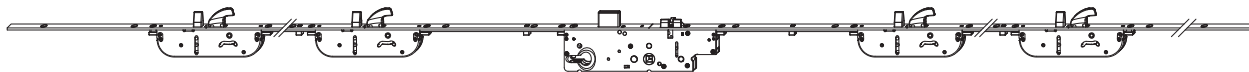

235814



| 2.2.1.3 Дверной замок Z-TS PT-M с 2 крюками-штырями Штульп F-16 | |  |  |  |  |  |  |  |  |  |  | № | € |
|---|----|---|---|---|---|---|--|---|---|---|---|---------------|----------|
| модуль | 92 | 35 | 8 | 1.050 | 1.950 - 2.400 | 16 | 2.400 | 5 | | | | 235810 | |
| | | | 10 | 1.050 | 1.950 - 2.400 | 16 | 2.400 | 5 | | | | 235820 | |
| | 40 | | 8 | 1.050 | 1.950 - 2.400 | 16 | 2.400 | 5 | | | | 235811 | |
| | | | 10 | 1.050 | 1.950 - 2.400 | 16 | 2.400 | 5 | | | | 235821 | |
| | 45 | | 8 | 1.050 | 1.950 - 2.400 | 16 | 2.400 | 5 | | | | 235812 | |
| | | | 10 | 1.050 | 1.950 - 2.400 | 16 | 2.400 | 5 | | | | 235822 | |
| | 50 | | 8 | 1.050 | 1.950 - 2.400 | 16 | 2.400 | 5 | | | | 235813 | |
| | | | 10 | 1.050 | 1.950 - 2.400 | 16 | 2.400 | 5 | | | | 235823 | |
| | 55 | | 8 | 1.050 | 1.950 - 2.400 | 16 | 2.400 | 5 | | | | 235814 | |
| | | | 10 | 1.050 | 1.950 - 2.400 | 16 | 2.400 | 5 | | | | 235824 | |
| | 65 | | 8 | 1.050 | 1.950 - 2.400 | 16 | 2.400 | 5 | | | | 235815 | |
| | | | 10 | 1.050 | 1.950 - 2.400 | 16 | 2.400 | 5 | | | | 235825 | |
| | 70 | | 8 | 1.050 | 1.950 - 2.400 | 16 | 2.400 | 5 | | | | 235816 | |
| | | | 10 | 1.050 | 1.950 - 2.400 | 16 | 2.400 | 5 | | | | 235826 | |
| | 80 | | 8 | 1.050 | 1.950 - 2.400 | 16 | 2.400 | 5 | | | | 235817 | |
| | | | 10 | 1.050 | 1.950 - 2.400 | 16 | 2.400 | 5 | | | | 235827 | |









234004



| 2.2.1.4 Дверной замок Z-TS PT-M с 4 крюками-штырями Штульп F-16 | |  |  |  |  |  |  |  |  |  | № | € | |
|---|----|---|---|---|---|---|--|---|---|---|----------|---------------|--|
| модуль | 92 | 35 | 8 | 1.050 | 1.950 - 2.400 | 16 | 2.400 | 5 | | | | 234000 | |
| | | | 10 | 1.050 | 1.950 - 2.400 | 16 | 2.400 | 5 | | | | 233990 | |
| | 40 | | 8 | 1.050 | 1.950 - 2.400 | 16 | 2.400 | 5 | | | | 234001 | |
| | | | 10 | 1.050 | 1.950 - 2.400 | 16 | 2.400 | 5 | | | | 233991 | |
| | 45 | | 8 | 1.050 | 1.950 - 2.400 | 16 | 2.400 | 5 | | | | 234002 | |
| | | | 10 | 1.050 | 1.950 - 2.400 | 16 | 2.400 | 5 | | | | 233992 | |
| | 50 | | 8 | 1.050 | 1.950 - 2.400 | 16 | 2.400 | 5 | | | | 234003 | |
| | | | 10 | 1.050 | 1.950 - 2.400 | 16 | 2.400 | 5 | | | | 233993 | |
| | 55 | | 8 | 1.050 | 1.950 - 2.400 | 16 | 2.400 | 5 | | | | 234004 | |
| | | | 10 | 1.050 | 1.950 - 2.400 | 16 | 2.400 | 5 | | | | 233994 | |
| | 65 | | 8 | 1.050 | 1.950 - 2.400 | 16 | 2.400 | 5 | | | | 234005 | |
| | | | 10 | 1.050 | 1.950 - 2.400 | 16 | 2.400 | 5 | | | | 233995 | |
| | 70 | | 8 | 1.050 | 1.950 - 2.400 | 16 | 2.400 | 5 | | | | 234006 | |
| | | | 10 | 1.050 | 1.950 - 2.400 | 16 | 2.400 | 5 | | | | 233996 | |
| | 80 | | 8 | 1.050 | 1.950 - 2.400 | 16 | 2.400 | 5 | | | | 234007 | |
| | | | 10 | 1.050 | 1.950 - 2.400 | 16 | 2.400 | 5 | | | | 233997 | |









238664



| 2.2.1.5 Дверной замок Z-TS PT-M с 2 крюками и 2 i.S. цапфами Штульп F-16 | |  |  |  |  |  |  |  |  | № | € |
|--|----|---|---|---|---|---|--|---|---|---------------|----------|
| модуль | 92 | 35 | 8 | 1.050 | 1.950 - 2.400 | 16 | 2.400 | 5 | | 238660 | |
| | | 10 | 1.050 | 1.950 - 2.400 | 16 | 2.400 | 5 | | 238670 | | |
| | 40 | 8 | 1.050 | 1.950 - 2.400 | 16 | 2.400 | 5 | | 238661 | | |
| | | 10 | 1.050 | 1.950 - 2.400 | 16 | 2.400 | 5 | | 238671 | | |
| | 45 | 8 | 1.050 | 1.950 - 2.400 | 16 | 2.400 | 5 | | 238662 | | |
| | | 10 | 1.050 | 1.950 - 2.400 | 16 | 2.400 | 5 | | 238672 | | |
| | 50 | 8 | 1.050 | 1.950 - 2.400 | 16 | 2.400 | 5 | | 238663 | | |
| | | 10 | 1.050 | 1.950 - 2.400 | 16 | 2.400 | 5 | | 238673 | | |
| | 55 | 8 | 1.050 | 1.950 - 2.400 | 16 | 2.400 | 5 | | 238664 | | |
| | | 10 | 1.050 | 1.950 - 2.400 | 16 | 2.400 | 5 | | 238674 | | |
| | 65 | 8 | 1.050 | 1.950 - 2.400 | 16 | 2.400 | 5 | | 238665 | | |
| | | 10 | 1.050 | 1.950 - 2.400 | 16 | 2.400 | 5 | | 238675 | | |
| | 70 | 8 | 1.050 | 1.950 - 2.400 | 16 | 2.400 | 5 | | 238666 | | |
| | | 10 | 1.050 | 1.950 - 2.400 | 16 | 2.400 | 5 | | 238676 | | |
| | 80 | 8 | 1.050 | 1.950 - 2.400 | 16 | 2.400 | 5 | | 238667 | | |
| | | 10 | 1.050 | 1.950 - 2.400 | 16 | 2.400 | 5 | | 238677 | | |







238354



| 2.2.1.6 Дверной замок Z-TS PT-M с 2 крюками Штульп F-16 | |  |  |  |  |  |  |  |  | № | € |
|---|----|---|---|---|---|---|--|---|---|---------------|----------|
| модуль | 92 | 35 | 8 | 1.050 | 1.950 - 2.400 | 16 | 2.400 | 5 | | 238350 | |
| | | 10 | 1.050 | 1.950 - 2.400 | 16 | 2.400 | 5 | | 238360 | | |
| | 40 | 8 | 1.050 | 1.950 - 2.400 | 16 | 2.400 | 5 | | 238351 | | |
| | | 10 | 1.050 | 1.950 - 2.400 | 16 | 2.400 | 5 | | 238361 | | |
| | 45 | 8 | 1.050 | 1.950 - 2.400 | 16 | 2.400 | 5 | | 238352 | | |
| | | 10 | 1.050 | 1.950 - 2.400 | 16 | 2.400 | 5 | | 238362 | | |
| | 50 | 8 | 1.050 | 1.950 - 2.400 | 16 | 2.400 | 5 | | 238353 | | |
| | | 10 | 1.050 | 1.950 - 2.400 | 16 | 2.400 | 5 | | 238363 | | |
| | 55 | 8 | 1.050 | 1.950 - 2.400 | 16 | 2.400 | 5 | | 238354 | | |
| | | 10 | 1.050 | 1.950 - 2.400 | 16 | 2.400 | 5 | | 238364 | | |
| | 65 | 8 | 1.050 | 1.950 - 2.400 | 16 | 2.400 | 5 | | 238355 | | |
| | | 10 | 1.050 | 1.950 - 2.400 | 16 | 2.400 | 5 | | 238365 | | |
| | 70 | 8 | 1.050 | 1.950 - 2.400 | 16 | 2.400 | 5 | | 238356 | | |
| | | 10 | 1.050 | 1.950 - 2.400 | 16 | 2.400 | 5 | | 238366 | | |
| | 80 | 8 | 1.050 | 1.950 - 2.400 | 16 | 2.400 | 5 | | 238357 | | |
| | | 10 | 1.050 | 1.950 - 2.400 | 16 | 2.400 | 5 | | 238367 | | |









238614

| 2.2.1.7 Дверной замок Z-TS PT-M с 2 штырями и 2 i.S. цапфами Штульп F-16 | |  |  |  |  |  |  | L |  | № | € |
|--|----|---|---|---|---|---|--|--------|---|---|---|
| модуль | 92 | 35 | 8 | 1.050 | 1.950 - 2.400 | 16 | 2.400 | 5 | 238610 | | |
| | | 10 | 1.050 | 1.950 - 2.400 | 16 | 2.400 | 5 | 238620 | | | |
| | 40 | 8 | 1.050 | 1.950 - 2.400 | 16 | 2.400 | 5 | 238611 | | | |
| | | 10 | 1.050 | 1.950 - 2.400 | 16 | 2.400 | 5 | 238621 | | | |
| | 45 | 8 | 1.050 | 1.950 - 2.400 | 16 | 2.400 | 5 | 238612 | | | |
| | | 10 | 1.050 | 1.950 - 2.400 | 16 | 2.400 | 5 | 238622 | | | |
| | 50 | 8 | 1.050 | 1.950 - 2.400 | 16 | 2.400 | 5 | 238613 | | | |
| | | 10 | 1.050 | 1.950 - 2.400 | 16 | 2.400 | 5 | 238623 | | | |
| | 55 | 8 | 1.050 | 1.950 - 2.400 | 16 | 2.400 | 5 | 238614 | | | |
| | | 10 | 1.050 | 1.950 - 2.400 | 16 | 2.400 | 5 | 238624 | | | |
| | 65 | 8 | 1.050 | 1.950 - 2.400 | 16 | 2.400 | 5 | 238615 | | | |
| | | 10 | 1.050 | 1.950 - 2.400 | 16 | 2.400 | 5 | 238625 | | | |
| | 70 | 8 | 1.050 | 1.950 - 2.400 | 16 | 2.400 | 5 | 238616 | | | |
| | | 10 | 1.050 | 1.950 - 2.400 | 16 | 2.400 | 5 | 238626 | | | |
| | 80 | 8 | 1.050 | 1.950 - 2.400 | 16 | 2.400 | 5 | 238617 | | | |
| | | 10 | 1.050 | 1.950 - 2.400 | 16 | 2.400 | 5 | 238627 | | | |









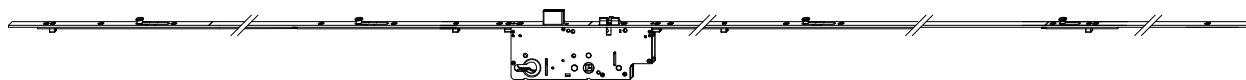

234604

| 2.2.1.8 Дверной замок Z-TS PT-M с 2 штырями Штульп F-16 | |  |  |  |  |  |  | L |  | № | € |
|--|----|---|---|---|---|---|--|--------|---|---|---|
| модуль | 92 | 35 | 8 | 1.050 | 1.950 - 2.400 | 16 | 2.400 | 5 | 234600 | | |
| | | 10 | 1.050 | 1.950 - 2.400 | 16 | 2.400 | 5 | 234450 | | | |
| | 40 | 8 | 1.050 | 1.950 - 2.400 | 16 | 2.400 | 5 | 234601 | | | |
| | | 10 | 1.050 | 1.950 - 2.400 | 16 | 2.400 | 5 | 234451 | | | |
| | 45 | 8 | 1.050 | 1.950 - 2.400 | 16 | 2.400 | 5 | 234602 | | | |
| | | 10 | 1.050 | 1.950 - 2.400 | 16 | 2.400 | 5 | 234452 | | | |
| | 50 | 8 | 1.050 | 1.950 - 2.400 | 16 | 2.400 | 5 | 234603 | | | |
| | | 10 | 1.050 | 1.950 - 2.400 | 16 | 2.400 | 5 | 234453 | | | |
| | 55 | 8 | 1.050 | 1.950 - 2.400 | 16 | 2.400 | 5 | 234604 | | | |
| | | 10 | 1.050 | 1.950 - 2.400 | 16 | 2.400 | 5 | 234454 | | | |
| | 65 | 8 | 1.050 | 1.950 - 2.400 | 16 | 2.400 | 5 | 234605 | | | |
| | | 10 | 1.050 | 1.950 - 2.400 | 16 | 2.400 | 5 | 234455 | | | |
| | 70 | 8 | 1.050 | 1.950 - 2.400 | 16 | 2.400 | 5 | 234606 | | | |
| | | 10 | 1.050 | 1.950 - 2.400 | 16 | 2.400 | 5 | 234456 | | | |
| | 80 | 8 | 1.050 | 1.950 - 2.400 | 16 | 2.400 | 5 | 234607 | | | |
| | | 10 | 1.050 | 1.950 - 2.400 | 16 | 2.400 | 5 | 234457 | | | |

2.2.2 Штульп F-20







230762



| 2.2.2.1 Дверной замок Z-TS PT с 4 i.S. цапфами Штульп F-20 |  |  |  |  |  |  | L |  | № | € |
|--|---|---|---|---|---|---|--------|--|--------|---|
| удлин. без ригеля | 92 | 25 | 8 | 1.050 | 1.950 - 2.400 | 20 | 2.400 | 5 | 234182 | |
| | | 30 | 8 | 1.050 | 1.950 - 2.400 | 20 | 2.400 | 5 | 234183 | |
| удлин. | 92 | 35 | 8 | 1.050 | 1.950 - 2.400 | 20 | 2.400 | 5 | 230760 | |
| | | 10 | 1.050 | 1.950 - 2.400 | 20 | 2.400 | 5 | 230260 | | |
| | 40 | 8 | 1.050 | 1.950 - 2.400 | 20 | 2.400 | 5 | 230761 | | |
| | | 10 | 1.050 | 1.950 - 2.400 | 20 | 2.400 | 5 | 230261 | | |
| | 45 | 8 | 1.050 | 1.950 - 2.400 | 20 | 2.400 | 5 | 230762 | | |
| | | 10 | 1.050 | 1.950 - 2.400 | 20 | 2.400 | 5 | 230262 | | |
| | 50 | 8 | 1.050 | 1.950 - 2.400 | 20 | 2.400 | 5 | 230763 | | |
| | | 10 | 1.050 | 1.950 - 2.400 | 20 | 2.400 | 5 | 230263 | | |
| | 55 | 8 | 1.050 | 1.950 - 2.400 | 20 | 2.400 | 5 | 230764 | | |
| | | 10 | 1.050 | 1.950 - 2.400 | 20 | 2.400 | 5 | 230264 | | |
| | 65 | 8 | 1.050 | 1.950 - 2.400 | 20 | 2.400 | 5 | 230765 | | |
| | | 10 | 1.050 | 1.950 - 2.400 | 20 | 2.400 | 5 | 230265 | | |
| | 70 | 8 | 1.050 | 1.950 - 2.400 | 20 | 2.400 | 5 | 230766 | | |
| | | 10 | 1.050 | 1.950 - 2.400 | 20 | 2.400 | 5 | 230266 | | |
| 80 | 8 | 1.050 | 1.950 - 2.400 | 20 | 2.400 | 5 | 230767 | | | |
| | 10 | 1.050 | 1.950 - 2.400 | 20 | 2.400 | 5 | 230267 | | | |









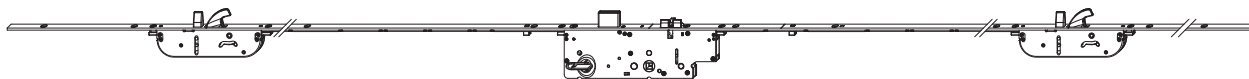



238714



| 2.2.2.2 Дверной замок Z-TS PT-M с 2 крюками-штырями и 2 i.S. цапфами Штульп F-20 |  |  |  |  |  |  | L |  | № | € |
|--|---|---|---|---|---|---|-------|--|--------|---|
| модуль | 92 | 35 | 8 | 1.050 | 1.950 - 2.400 | 20 | 2.400 | 5 | 238710 | |
| | | 10 | 1.050 | 1.950 - 2.400 | 20 | 2.400 | 5 | 238720 | | |
| | 40 | 8 | 1.050 | 1.950 - 2.400 | 20 | 2.400 | 5 | 238711 | | |
| | | 10 | 1.050 | 1.950 - 2.400 | 20 | 2.400 | 5 | 238721 | | |
| | 45 | 8 | 1.050 | 1.950 - 2.400 | 20 | 2.400 | 5 | 238712 | | |
| | | 10 | 1.050 | 1.950 - 2.400 | 20 | 2.400 | 5 | 238722 | | |
| | 50 | 8 | 1.050 | 1.950 - 2.400 | 20 | 2.400 | 5 | 238713 | | |
| | | 10 | 1.050 | 1.950 - 2.400 | 20 | 2.400 | 5 | 238723 | | |
| | 55 | 8 | 1.050 | 1.950 - 2.400 | 20 | 2.400 | 5 | 238714 | | |
| | | 10 | 1.050 | 1.950 - 2.400 | 20 | 2.400 | 5 | 238724 | | |
| | 65 | 8 | 1.050 | 1.950 - 2.400 | 20 | 2.400 | 5 | 238715 | | |
| | | 10 | 1.050 | 1.950 - 2.400 | 20 | 2.400 | 5 | 238725 | | |
| | 70 | 8 | 1.050 | 1.950 - 2.400 | 20 | 2.400 | 5 | 238716 | | |
| | | 10 | 1.050 | 1.950 - 2.400 | 20 | 2.400 | 5 | 238726 | | |
| | 80 | 8 | 1.050 | 1.950 - 2.400 | 20 | 2.400 | 5 | 238717 | | |
| | | 10 | 1.050 | 1.950 - 2.400 | 20 | 2.400 | 5 | 238727 | | |













235854



| 2.2.2.3 Дверной замок Z-TS PT-M с 2 крюками-штырями Штульп F-20 | |  |  |  |  |  |  |  |  |  |  |  |  |
|---|----|---|---|---|---|---|--|---|---|---|---|---|---|
| модуль | 92 | 35 | 8 | 1.050 | 1.950 - 2.400 | 20 | 2.400 | 5 | 235850 | € | | | |
| | | | 10 | 1.050 | 1.950 - 2.400 | 20 | 2.400 | 5 | 235860 | | | | |
| | 40 | 8 | 1.050 | 1.950 - 2.400 | 20 | 2.400 | 5 | 235851 | | | | | |
| | | | 10 | 1.050 | 1.950 - 2.400 | 20 | 2.400 | 5 | 235861 | | | | |
| | 45 | 8 | 1.050 | 1.950 - 2.400 | 20 | 2.400 | 5 | 235852 | | | | | |
| | | | 10 | 1.050 | 1.950 - 2.400 | 20 | 2.400 | 5 | 235862 | | | | |
| | 50 | 8 | 1.050 | 1.950 - 2.400 | 20 | 2.400 | 5 | 235853 | | | | | |
| | | | 10 | 1.050 | 1.950 - 2.400 | 20 | 2.400 | 5 | 235863 | | | | |
| | 55 | 8 | 1.050 | 1.950 - 2.400 | 20 | 2.400 | 5 | 235854 | | | | | |
| | | | 10 | 1.050 | 1.950 - 2.400 | 20 | 2.400 | 5 | 235864 | | | | |
| | 65 | 8 | 1.050 | 1.950 - 2.400 | 20 | 2.400 | 5 | 235855 | | | | | |
| | | | 10 | 1.050 | 1.950 - 2.400 | 20 | 2.400 | 5 | 235865 | | | | |
| | 70 | 8 | 1.050 | 1.950 - 2.400 | 20 | 2.400 | 5 | 235856 | | | | | |
| | | | 10 | 1.050 | 1.950 - 2.400 | 20 | 2.400 | 5 | 235866 | | | | |
| | 80 | 8 | 1.050 | 1.950 - 2.400 | 20 | 2.400 | 5 | 235857 | | | | | |
| | | | 10 | 1.050 | 1.950 - 2.400 | 20 | 2.400 | 5 | 235867 | | | | |

235124



| 2.2.2.4 Дверной замок Z-TS PT-M с 4 крюками-штырями Штульп F-20 | |  |  |  |  |  |  |  |  |  |  |  |  |
|---|----|---|---|---|---|---|--|---|---|---|---|---|---|
| модуль | 92 | 35 | 8 | 1.050 | 1.950 - 2.400 | 20 | 2.400 | 5 | 235120 | € | | | |
| | | | 10 | 1.050 | 1.950 - 2.400 | 20 | 2.400 | 5 | 235110 | | | | |
| | 40 | 8 | 1.050 | 1.950 - 2.400 | 20 | 2.400 | 5 | 235121 | | | | | |
| | | | 10 | 1.050 | 1.950 - 2.400 | 20 | 2.400 | 5 | 235111 | | | | |
| | 45 | 8 | 1.050 | 1.950 - 2.400 | 20 | 2.400 | 5 | 235122 | | | | | |
| | | | 10 | 1.050 | 1.950 - 2.400 | 20 | 2.400 | 5 | 235112 | | | | |
| | 50 | 8 | 1.050 | 1.950 - 2.400 | 20 | 2.400 | 5 | 235123 | | | | | |
| | | | 10 | 1.050 | 1.950 - 2.400 | 20 | 2.400 | 5 | 235113 | | | | |
| | 55 | 8 | 1.050 | 1.950 - 2.400 | 20 | 2.400 | 5 | 235124 | | | | | |
| | | | 10 | 1.050 | 1.950 - 2.400 | 20 | 2.400 | 5 | 235114 | | | | |
| | 65 | 8 | 1.050 | 1.950 - 2.400 | 20 | 2.400 | 5 | 235125 | | | | | |
| | | | 10 | 1.050 | 1.950 - 2.400 | 20 | 2.400 | 5 | 235115 | | | | |
| | 70 | 8 | 1.050 | 1.950 - 2.400 | 20 | 2.400 | 5 | 235126 | | | | | |
| | | | 10 | 1.050 | 1.950 - 2.400 | 20 | 2.400 | 5 | 235116 | | | | |
| | 80 | 8 | 1.050 | 1.950 - 2.400 | 20 | 2.400 | 5 | 235127 | | | | | |
| | | | 10 | 1.050 | 1.950 - 2.400 | 20 | 2.400 | 5 | 235117 | | | | |

238814



| 2.2.2.5 Дверной замок Z-TS PT-M с 2 крюками и 2 i.S. цапфами Штульп F-20 | | | | | | | L | | № | € |
|--|----|----|-------|---------------|---------------|-------|-------|--------|--------|---|
| модуль | 92 | 35 | 8 | 1.050 | 1.950 - 2.400 | 20 | 2.400 | 5 | 238810 | |
| | | 10 | 1.050 | 1.950 - 2.400 | 20 | 2.400 | 5 | 238820 | | |
| | 40 | 8 | 1.050 | 1.950 - 2.400 | 20 | 2.400 | 5 | 238811 | | |
| | | 10 | 1.050 | 1.950 - 2.400 | 20 | 2.400 | 5 | 238821 | | |
| | 45 | 8 | 1.050 | 1.950 - 2.400 | 20 | 2.400 | 5 | 238812 | | |
| | | 10 | 1.050 | 1.950 - 2.400 | 20 | 2.400 | 5 | 238822 | | |
| | 50 | 8 | 1.050 | 1.950 - 2.400 | 20 | 2.400 | 5 | 238813 | | |
| | | 10 | 1.050 | 1.950 - 2.400 | 20 | 2.400 | 5 | 238823 | | |
| | 55 | 8 | 1.050 | 1.950 - 2.400 | 20 | 2.400 | 5 | 238814 | | |
| | | 10 | 1.050 | 1.950 - 2.400 | 20 | 2.400 | 5 | 238824 | | |
| | 65 | 8 | 1.050 | 1.950 - 2.400 | 20 | 2.400 | 5 | 238815 | | |
| | | 10 | 1.050 | 1.950 - 2.400 | 20 | 2.400 | 5 | 238825 | | |
| | 70 | 8 | 1.050 | 1.950 - 2.400 | 20 | 2.400 | 5 | 238816 | | |
| | | 10 | 1.050 | 1.950 - 2.400 | 20 | 2.400 | 5 | 238826 | | |
| | 80 | 8 | 1.050 | 1.950 - 2.400 | 20 | 2.400 | 5 | 238817 | | |
| | | 10 | 1.050 | 1.950 - 2.400 | 20 | 2.400 | 5 | 238827 | | |















234324



| 2.2.2.6 Дверной замок Z-TS PT-M с 2 крюками Штульп F-20 | | | | | | | L | | № | € |
|---|----|----|-------|---------------|---------------|-------|-------|--------|--------|---|
| модуль | 92 | 35 | 8 | 1.050 | 1.950 - 2.400 | 20 | 2.400 | 5 | 234320 | |
| | | 10 | 1.050 | 1.950 - 2.400 | 20 | 2.400 | 5 | 234330 | | |
| | 40 | 8 | 1.050 | 1.950 - 2.400 | 20 | 2.400 | 5 | 234321 | | |
| | | 10 | 1.050 | 1.950 - 2.400 | 20 | 2.400 | 5 | 234331 | | |
| | 45 | 8 | 1.050 | 1.950 - 2.400 | 20 | 2.400 | 5 | 234322 | | |
| | | 10 | 1.050 | 1.950 - 2.400 | 20 | 2.400 | 5 | 234332 | | |
| | 50 | 8 | 1.050 | 1.950 - 2.400 | 20 | 2.400 | 5 | 234323 | | |
| | | 10 | 1.050 | 1.950 - 2.400 | 20 | 2.400 | 5 | 234333 | | |
| | 55 | 8 | 1.050 | 1.950 - 2.400 | 20 | 2.400 | 5 | 234324 | | |
| | | 10 | 1.050 | 1.950 - 2.400 | 20 | 2.400 | 5 | 234334 | | |
| | 65 | 8 | 1.050 | 1.950 - 2.400 | 20 | 2.400 | 5 | 234325 | | |
| | | 10 | 1.050 | 1.950 - 2.400 | 20 | 2.400 | 5 | 234335 | | |
| | 70 | 8 | 1.050 | 1.950 - 2.400 | 20 | 2.400 | 5 | 234326 | | |
| | | 10 | 1.050 | 1.950 - 2.400 | 20 | 2.400 | 5 | 234336 | | |
| | 80 | 8 | 1.050 | 1.950 - 2.400 | 20 | 2.400 | 5 | 234327 | | |
| | | 10 | 1.050 | 1.950 - 2.400 | 20 | 2.400 | 5 | 234337 | | |















238764



| 2.2.2.7 Дверной замок Z-TS PT-M с 2 штырями и 2 i.S. цапфами Штульп F-20 | |  |  |  |  |  |  |  |  |  |  |  |  |  |  |  |
|--|----|---|---|---|---|---|--|---|---|---|---|---|---|---|---|---|
| модуль | 92 | 35 | 8 | 1.050 | 1.950 - 2.400 | 20 | 2.400 | 5 | 238760 | | | | | | | |
| | | | 10 | 1.050 | 1.950 - 2.400 | 20 | 2.400 | 5 | 238770 | | | | | | | |
| | 40 | 8 | 1.050 | 1.950 - 2.400 | 20 | 2.400 | 5 | 238761 | | | | | | | | |
| | | | 10 | 1.050 | 1.950 - 2.400 | 20 | 2.400 | 5 | 238771 | | | | | | | |
| | 45 | 8 | 1.050 | 1.950 - 2.400 | 20 | 2.400 | 5 | 238762 | | | | | | | | |
| | | | 10 | 1.050 | 1.950 - 2.400 | 20 | 2.400 | 5 | 238772 | | | | | | | |
| | 50 | 8 | 1.050 | 1.950 - 2.400 | 20 | 2.400 | 5 | 238763 | | | | | | | | |
| | | | 10 | 1.050 | 1.950 - 2.400 | 20 | 2.400 | 5 | 238773 | | | | | | | |
| | 55 | 8 | 1.050 | 1.950 - 2.400 | 20 | 2.400 | 5 | 238764 | | | | | | | | |
| | | | 10 | 1.050 | 1.950 - 2.400 | 20 | 2.400 | 5 | 238774 | | | | | | | |
| | 65 | 8 | 1.050 | 1.950 - 2.400 | 20 | 2.400 | 5 | 238765 | | | | | | | | |
| | | | 10 | 1.050 | 1.950 - 2.400 | 20 | 2.400 | 5 | 238775 | | | | | | | |
| | 70 | 8 | 1.050 | 1.950 - 2.400 | 20 | 2.400 | 5 | 238766 | | | | | | | | |
| | | | 10 | 1.050 | 1.950 - 2.400 | 20 | 2.400 | 5 | 238776 | | | | | | | |
| | 80 | 8 | 1.050 | 1.950 - 2.400 | 20 | 2.400 | 5 | 238767 | | | | | | | | |
| | | | 10 | 1.050 | 1.950 - 2.400 | 20 | 2.400 | 5 | 238777 | | | | | | | |

234504







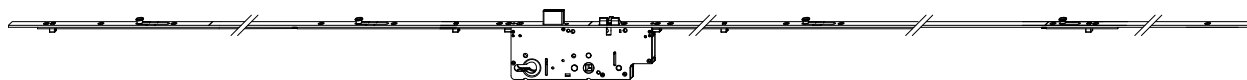

| 2.2.2.8 Дверной замок Z-TS PT-M с 2 штырями Штульп F-20 | |  |  |  |  |  |  |  |  |  |  |  |  |  |  |  |
|---|----|---|---|---|---|---|--|---|---|---|---|---|---|---|---|---|
| модуль | 92 | 35 | 8 | 1.050 | 1.950 - 2.400 | 20 | 2.400 | 5 | 234500 | | | | | | | |
| | | | 10 | 1.050 | 1.950 - 2.400 | 20 | 2.400 | 5 | 234510 | | | | | | | |
| | 40 | 8 | 1.050 | 1.950 - 2.400 | 20 | 2.400 | 5 | 234501 | | | | | | | | |
| | | | 10 | 1.050 | 1.950 - 2.400 | 20 | 2.400 | 5 | 234511 | | | | | | | |
| | 45 | 8 | 1.050 | 1.950 - 2.400 | 20 | 2.400 | 5 | 234502 | | | | | | | | |
| | | | 10 | 1.050 | 1.950 - 2.400 | 20 | 2.400 | 5 | 234512 | | | | | | | |
| | 50 | 8 | 1.050 | 1.950 - 2.400 | 20 | 2.400 | 5 | 234503 | | | | | | | | |
| | | | 10 | 1.050 | 1.950 - 2.400 | 20 | 2.400 | 5 | 234513 | | | | | | | |
| | 55 | 8 | 1.050 | 1.950 - 2.400 | 20 | 2.400 | 5 | 234504 | | | | | | | | |
| | | | 10 | 1.050 | 1.950 - 2.400 | 20 | 2.400 | 5 | 234514 | | | | | | | |
| | 65 | 8 | 1.050 | 1.950 - 2.400 | 20 | 2.400 | 5 | 234505 | | | | | | | | |
| | | | 10 | 1.050 | 1.950 - 2.400 | 20 | 2.400 | 5 | 234515 | | | | | | | |
| | 70 | 8 | 1.050 | 1.950 - 2.400 | 20 | 2.400 | 5 | 234506 | | | | | | | | |
| | | | 10 | 1.050 | 1.950 - 2.400 | 20 | 2.400 | 5 | 234516 | | | | | | | |
| | 80 | 8 | 1.050 | 1.950 - 2.400 | 20 | 2.400 | 5 | 234507 | | | | | | | | |
| | | | 10 | 1.050 | 1.950 - 2.400 | 20 | 2.400 | 5 | 234517 | | | | | | | |

2.2.3 Штульп F-24







231244



| 2.2.3.1 Дверной замок Z-TS PT с 4 i.S. цапфами Штульп F-24 |  |  |  |  |  |  | L |  | № | € |
|--|---|---|---|---|---|---|--------|--|--------|---|
| удлин. без ригеля | 92 | 25 | 8 | 1.050 | 1.950 - 2.400 | 24 | 2.400 | 5 | 234184 | |
| | | 30 | 8 | 1.050 | 1.950 - 2.400 | 24 | 2.400 | 5 | 234185 | |
| удлин. | 92 | 35 | 8 | 1.050 | 1.950 - 2.400 | 24 | 2.400 | 5 | 231240 | |
| | | | 10 | 1.050 | 1.950 - 2.400 | 24 | 2.400 | 5 | 230930 | |
| | | 40 | 8 | 1.050 | 1.950 - 2.400 | 24 | 2.400 | 5 | 231241 | |
| | | | 10 | 1.050 | 1.950 - 2.400 | 24 | 2.400 | 5 | 230931 | |
| | | 45 | 8 | 1.050 | 1.950 - 2.400 | 24 | 2.400 | 5 | 231242 | |
| | | | 10 | 1.050 | 1.950 - 2.400 | 24 | 2.400 | 5 | 230932 | |
| | | 50 | 8 | 1.050 | 1.950 - 2.400 | 24 | 2.400 | 5 | 231243 | |
| | | | 10 | 1.050 | 1.950 - 2.400 | 24 | 2.400 | 5 | 230933 | |
| | | 55 | 8 | 1.050 | 1.950 - 2.400 | 24 | 2.400 | 5 | 231244 | |
| | | | 10 | 1.050 | 1.950 - 2.400 | 24 | 2.400 | 5 | 230934 | |
| | | 65 | 8 | 1.050 | 1.950 - 2.400 | 24 | 2.400 | 5 | 231245 | |
| | | | 10 | 1.050 | 1.950 - 2.400 | 24 | 2.400 | 5 | 230935 | |
| | | 70 | 8 | 1.050 | 1.950 - 2.400 | 24 | 2.400 | 5 | 231246 | |
| | | | 10 | 1.050 | 1.950 - 2.400 | 24 | 2.400 | 5 | 230936 | |
| 80 | 8 | 1.050 | 1.950 - 2.400 | 24 | 2.400 | 5 | 231247 | | | |
| | 10 | 1.050 | 1.950 - 2.400 | 24 | 2.400 | 5 | 230937 | | | |

235894



| 2.2.3.2 Дверной замок Z-TS PT-M с 2 крюками-штырями Штульп F-24 |  |  |  |  |  |  | L |  | № | € |
|---|---|---|---|---|---|---|-------|--|--------|---|
| модуль | 92 | 35 | 8 | 1.050 | 1.950 - 2.400 | 24 | 2.400 | 5 | 235890 | |
| | | | 10 | 1.050 | 1.950 - 2.400 | 24 | 2.400 | 5 | 235900 | |
| | | 40 | 8 | 1.050 | 1.950 - 2.400 | 24 | 2.400 | 5 | 235891 | |
| | | | 10 | 1.050 | 1.950 - 2.400 | 24 | 2.400 | 5 | 235901 | |
| | | 45 | 8 | 1.050 | 1.950 - 2.400 | 24 | 2.400 | 5 | 235892 | |
| | | | 10 | 1.050 | 1.950 - 2.400 | 24 | 2.400 | 5 | 235902 | |
| | | 50 | 8 | 1.050 | 1.950 - 2.400 | 24 | 2.400 | 5 | 235893 | |
| | | | 10 | 1.050 | 1.950 - 2.400 | 24 | 2.400 | 5 | 235903 | |
| | | 55 | 8 | 1.050 | 1.950 - 2.400 | 24 | 2.400 | 5 | 235894 | |
| | | | 10 | 1.050 | 1.950 - 2.400 | 24 | 2.400 | 5 | 235904 | |
| | | 65 | 8 | 1.050 | 1.950 - 2.400 | 24 | 2.400 | 5 | 235895 | |
| | | | 10 | 1.050 | 1.950 - 2.400 | 24 | 2.400 | 5 | 235905 | |
| | | 70 | 8 | 1.050 | 1.950 - 2.400 | 24 | 2.400 | 5 | 235896 | |
| | | | 10 | 1.050 | 1.950 - 2.400 | 24 | 2.400 | 5 | 235906 | |
| | | 80 | 8 | 1.050 | 1.950 - 2.400 | 24 | 2.400 | 5 | 235897 | |
| | | | 10 | 1.050 | 1.950 - 2.400 | 24 | 2.400 | 5 | 235907 | |

234384

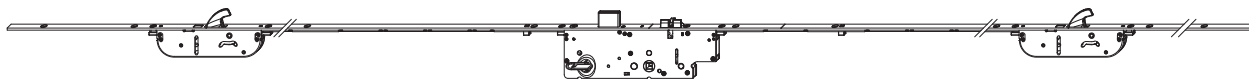

| 2.2.3.3 Дверной замок Z-TS PT-M с 2 крюками Штульп F-24 | | | | | | | | L | | № | € |
|---|----|----|-------|---------------|---------------|-------|-------|--------|--------|---|---|
| модуль | 92 | 35 | 8 | 1.050 | 1.950 - 2.400 | 24 | 2.400 | 5 | 234380 | | |
| | | 10 | 1.050 | 1.950 - 2.400 | 24 | 2.400 | 5 | 234390 | | | |
| | 40 | 8 | 1.050 | 1.950 - 2.400 | 24 | 2.400 | 5 | 234381 | | | |
| | | 10 | 1.050 | 1.950 - 2.400 | 24 | 2.400 | 5 | 234391 | | | |
| | 45 | 8 | 1.050 | 1.950 - 2.400 | 24 | 2.400 | 5 | 234382 | | | |
| | | 10 | 1.050 | 1.950 - 2.400 | 24 | 2.400 | 5 | 234392 | | | |
| | 50 | 8 | 1.050 | 1.950 - 2.400 | 24 | 2.400 | 5 | 234383 | | | |
| | | 10 | 1.050 | 1.950 - 2.400 | 24 | 2.400 | 5 | 234393 | | | |
| | 55 | 8 | 1.050 | 1.950 - 2.400 | 24 | 2.400 | 5 | 234384 | | | |
| | | 10 | 1.050 | 1.950 - 2.400 | 24 | 2.400 | 5 | 234394 | | | |
| | 65 | 8 | 1.050 | 1.950 - 2.400 | 24 | 2.400 | 5 | 234385 | | | |
| | | 10 | 1.050 | 1.950 - 2.400 | 24 | 2.400 | 5 | 234395 | | | |
| | 70 | 8 | 1.050 | 1.950 - 2.400 | 24 | 2.400 | 5 | 234386 | | | |
| | | 10 | 1.050 | 1.950 - 2.400 | 24 | 2.400 | 5 | 234396 | | | |
| | 80 | 8 | 1.050 | 1.950 - 2.400 | 24 | 2.400 | 5 | 234387 | | | |
| | | 10 | 1.050 | 1.950 - 2.400 | 24 | 2.400 | 5 | 234397 | | | |

234564

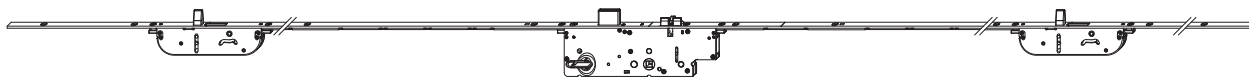

| 2.2.3.4 Дверной замок Z-TS PT-M с 2 штырями Штульп F-24 | | | | | | | | L | | № | € |
|---|----|----|-------|---------------|---------------|-------|-------|--------|--------|---|---|
| модуль | 92 | 35 | 8 | 1.050 | 1.950 - 2.400 | 24 | 2.400 | 5 | 234560 | | |
| | | 10 | 1.050 | 1.950 - 2.400 | 24 | 2.400 | 5 | 234570 | | | |
| | 40 | 8 | 1.050 | 1.950 - 2.400 | 24 | 2.400 | 5 | 234561 | | | |
| | | 10 | 1.050 | 1.950 - 2.400 | 24 | 2.400 | 5 | 234571 | | | |
| | 45 | 8 | 1.050 | 1.950 - 2.400 | 24 | 2.400 | 5 | 234562 | | | |
| | | 10 | 1.050 | 1.950 - 2.400 | 24 | 2.400 | 5 | 234572 | | | |
| | 50 | 8 | 1.050 | 1.950 - 2.400 | 24 | 2.400 | 5 | 234563 | | | |
| | | 10 | 1.050 | 1.950 - 2.400 | 24 | 2.400 | 5 | 234573 | | | |
| | 55 | 8 | 1.050 | 1.950 - 2.400 | 24 | 2.400 | 5 | 234564 | | | |
| | | 10 | 1.050 | 1.950 - 2.400 | 24 | 2.400 | 5 | 234574 | | | |
| | 65 | 8 | 1.050 | 1.950 - 2.400 | 24 | 2.400 | 5 | 234565 | | | |
| | | 10 | 1.050 | 1.950 - 2.400 | 24 | 2.400 | 5 | 234575 | | | |
| | 70 | 8 | 1.050 | 1.950 - 2.400 | 24 | 2.400 | 5 | 234566 | | | |
| | | 10 | 1.050 | 1.950 - 2.400 | 24 | 2.400 | 5 | 234576 | | | |
| | 80 | 8 | 1.050 | 1.950 - 2.400 | 24 | 2.400 | 5 | 234567 | | | |
| | | 10 | 1.050 | 1.950 - 2.400 | 24 | 2.400 | 5 | 234577 | | | |

2.2.4 Штульп F-24/16 Hutstulp *

* Детальную информацию по Hutstulp Вы найдёте в разделе 10 "Технические данные и информация"

237604

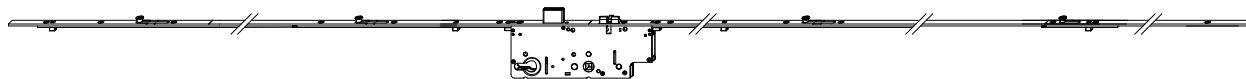

2.2.4.1 Дверной замок Z-TS PT
с 4 i.S. цапфами Штульп F-24/16



| удлин. | 92 | 35 | 8 | 1.050 | 1.950 - 2.400 | 24 | 2.400 | 5 | № | € |
|--------|----|----|-------|---------------|---------------|-------|-------|--------|--------|---|
| | | | 10 | 1.050 | 1.950 - 2.400 | 24 | 2.400 | 5 | 237590 | |
| | 40 | 8 | 1.050 | 1.950 - 2.400 | 24 | 2.400 | 5 | 237601 | | |
| | | 10 | 1.050 | 1.950 - 2.400 | 24 | 2.400 | 5 | 237591 | | |
| | 45 | 8 | 1.050 | 1.950 - 2.400 | 24 | 2.400 | 5 | 237602 | | |
| | | 10 | 1.050 | 1.950 - 2.400 | 24 | 2.400 | 5 | 237592 | | |
| | 50 | 8 | 1.050 | 1.950 - 2.400 | 24 | 2.400 | 5 | 237603 | | |
| | | 10 | 1.050 | 1.950 - 2.400 | 24 | 2.400 | 5 | 237593 | | |
| | 55 | 8 | 1.050 | 1.950 - 2.400 | 24 | 2.400 | 5 | 237604 | | |
| | | 10 | 1.050 | 1.950 - 2.400 | 24 | 2.400 | 5 | 237594 | | |
| | 65 | 8 | 1.050 | 1.950 - 2.400 | 24 | 2.400 | 5 | 237605 | | |
| | | 10 | 1.050 | 1.950 - 2.400 | 24 | 2.400 | 5 | 237595 | | |
| | 70 | 8 | 1.050 | 1.950 - 2.400 | 24 | 2.400 | 5 | 237606 | | |
| | | 10 | 1.050 | 1.950 - 2.400 | 24 | 2.400 | 5 | 237596 | | |
| | 80 | 8 | 1.050 | 1.950 - 2.400 | 24 | 2.400 | 5 | 237607 | | |
| | | 10 | 1.050 | 1.950 - 2.400 | 24 | 2.400 | 5 | 237597 | | |

237624









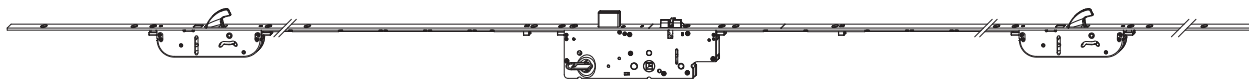

2.2.4.2 Дверной замок Z-TS PT-M
с 2 крюками-штырями
Штульп F-24/16



| удлин. | 92 | 35 | 8 | 1.050 | 1.950 - 2.400 | 24 | 2.400 | 5 | № | € |
|--------|----|----|-------|---------------|---------------|-------|-------|--------|--------|---|
| | | | 10 | 1.050 | 1.950 - 2.400 | 24 | 2.400 | 5 | 237630 | |
| | 40 | 8 | 1.050 | 1.950 - 2.400 | 24 | 2.400 | 5 | 237621 | | |
| | | 10 | 1.050 | 1.950 - 2.400 | 24 | 2.400 | 5 | 237631 | | |
| | 45 | 8 | 1.050 | 1.950 - 2.400 | 24 | 2.400 | 5 | 237622 | | |
| | | 10 | 1.050 | 1.950 - 2.400 | 24 | 2.400 | 5 | 237632 | | |
| | 50 | 8 | 1.050 | 1.950 - 2.400 | 24 | 2.400 | 5 | 237623 | | |
| | | 10 | 1.050 | 1.950 - 2.400 | 24 | 2.400 | 5 | 237633 | | |
| | 55 | 8 | 1.050 | 1.950 - 2.400 | 24 | 2.400 | 5 | 237624 | | |
| | | 10 | 1.050 | 1.950 - 2.400 | 24 | 2.400 | 5 | 237634 | | |
| | 65 | 8 | 1.050 | 1.950 - 2.400 | 24 | 2.400 | 5 | 237625 | | |
| | | 10 | 1.050 | 1.950 - 2.400 | 24 | 2.400 | 5 | 237635 | | |
| | 70 | 8 | 1.050 | 1.950 - 2.400 | 24 | 2.400 | 5 | 237626 | | |
| | | 10 | 1.050 | 1.950 - 2.400 | 24 | 2.400 | 5 | 237636 | | |
| | 80 | 8 | 1.050 | 1.950 - 2.400 | 24 | 2.400 | 5 | 237627 | | |
| | | 10 | 1.050 | 1.950 - 2.400 | 24 | 2.400 | 5 | 237637 | | |







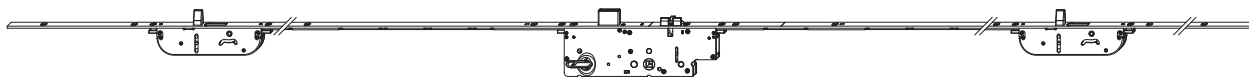



239494

| 2.2.4.3 Дверной замок Z-TS PT-M с 2 крюками Штульп F-24/16 | |  |  |  |  |  |  |  |  |  | № | € |
|--|----|---|---|---|---|---|--|---|---|---|--------|---|
| модуль | 92 | 35 | 8 | 1.050 | 1.950 - 2.400 | 24 | 2.400 | 5 | | | 239490 | |
| | | | 10 | 1.050 | 1.950 - 2.400 | 24 | 2.400 | 5 | | | 239500 | |
| | 40 | 8 | 1.050 | 1.950 - 2.400 | 24 | 2.400 | 5 | | | 239491 | | |
| | | | 10 | 1.050 | 1.950 - 2.400 | 24 | 2.400 | 5 | | | 239501 | |
| | 45 | 8 | 1.050 | 1.950 - 2.400 | 24 | 2.400 | 5 | | | 239492 | | |
| | | | 10 | 1.050 | 1.950 - 2.400 | 24 | 2.400 | 5 | | | 239502 | |
| | 50 | 8 | 1.050 | 1.950 - 2.400 | 24 | 2.400 | 5 | | | 239493 | | |
| | | | 10 | 1.050 | 1.950 - 2.400 | 24 | 2.400 | 5 | | | 239503 | |
| | 55 | 8 | 1.050 | 1.950 - 2.400 | 24 | 2.400 | 5 | | | 239494 | | |
| | | | 10 | 1.050 | 1.950 - 2.400 | 24 | 2.400 | 5 | | | 239504 | |
| | 65 | 8 | 1.050 | 1.950 - 2.400 | 24 | 2.400 | 5 | | | 239495 | | |
| | | | 10 | 1.050 | 1.950 - 2.400 | 24 | 2.400 | 5 | | | 239505 | |
| | 70 | 8 | 1.050 | 1.950 - 2.400 | 24 | 2.400 | 5 | | | 239496 | | |
| | | | 10 | 1.050 | 1.950 - 2.400 | 24 | 2.400 | 5 | | | 239506 | |
| | 80 | 8 | 1.050 | 1.950 - 2.400 | 24 | 2.400 | 5 | | | 239497 | | |
| | | | 10 | 1.050 | 1.950 - 2.400 | 24 | 2.400 | 5 | | | 239507 | |









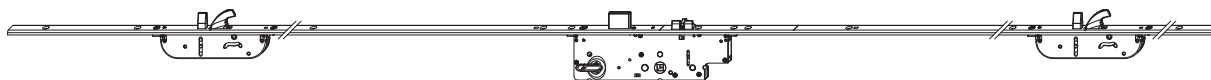

239474

| 2.2.4.4 Дверной замок Z-TS PT-M с 2 штырями Штульп F-24/16 | |  |  |  |  |  |  |  |  | № | € | |
|--|----|---|---|---|---|---|--|---|---|--------|--------|--|
| модуль | 92 | 35 | 8 | 1.050 | 1.950 - 2.400 | 24 | 2.400 | 5 | | | 239470 | |
| | | | 10 | 1.050 | 1.950 - 2.400 | 24 | 2.400 | 5 | | | 239480 | |
| | 40 | 8 | 1.050 | 1.950 - 2.400 | 24 | 2.400 | 5 | | | 239471 | | |
| | | | 10 | 1.050 | 1.950 - 2.400 | 24 | 2.400 | 5 | | | 239481 | |
| | 45 | 8 | 1.050 | 1.950 - 2.400 | 24 | 2.400 | 5 | | | 239472 | | |
| | | | 10 | 1.050 | 1.950 - 2.400 | 24 | 2.400 | 5 | | | 239482 | |
| | 50 | 8 | 1.050 | 1.950 - 2.400 | 24 | 2.400 | 5 | | | 239473 | | |
| | | | 10 | 1.050 | 1.950 - 2.400 | 24 | 2.400 | 5 | | | 239483 | |
| | 55 | 8 | 1.050 | 1.950 - 2.400 | 24 | 2.400 | 5 | | | 239474 | | |
| | | | 10 | 1.050 | 1.950 - 2.400 | 24 | 2.400 | 5 | | | 239484 | |
| | 65 | 8 | 1.050 | 1.950 - 2.400 | 24 | 2.400 | 5 | | | 239475 | | |
| | | | 10 | 1.050 | 1.950 - 2.400 | 24 | 2.400 | 5 | | | 239485 | |
| | 70 | 8 | 1.050 | 1.950 - 2.400 | 24 | 2.400 | 5 | | | 239476 | | |
| | | | 10 | 1.050 | 1.950 - 2.400 | 24 | 2.400 | 5 | | | 239486 | |
| | 80 | 8 | 1.050 | 1.950 - 2.400 | 24 | 2.400 | 5 | | | 239477 | | |
| | | | 10 | 1.050 | 1.950 - 2.400 | 24 | 2.400 | 5 | | | 239487 | |

2.2.5 U-штульп 6x24x6 GM1050

236602



| 2.2.5.1 Дверной замок Z-TS PT-M с 2 крюками-штырями U-штульп U-6x24x6 |  |  |  |  |  |  | L |  | № | € |
|---|---|---|---|---|---|--|-------|---|--------|----|
| модуль | 92 | 35 | 8 | 1.050 | 1.950 - 2.200 | 24 | 2.200 | 5 | 236600 | |
| | | | 10 | 1.050 | 1.950 - 2.200 | 24 | 2.200 | 5 | 236590 | |
| | 40 | 8 | 1.050 | 1.950 - 2.200 | 24 | 2.200 | 5 | 236601 | | |
| | | | | | | | | | | 10 |
| | 45 | 8 | 1.050 | 1.950 - 2.200 | 24 | 2.200 | 5 | 236602 | | |
| | | | | | | | | | | 10 |

103001









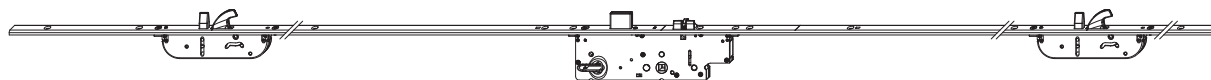

| 2.2.5.2 Декоративный U-штульп 6x24x6 |  | L |  | № | € |
|--------------------------------------|--|----|---|---|--------|
| Накладной шульп . | У-штульп | 24 | 1.000 | 5 | 103001 |

2.2.6 Штульп U-6x24x6 GM1020









234102



| 2.2.6.1 Дверной замок Z-TS PT-M с 2 крюками-штырями U-штульп U-6x24x6 |  |  |  |  |  |  |  |  |  | № | € |
|---|---|---|---|---|---|--|---|---|---|--------|---|
| модуль GM 1020 | 92 | 35 | 8 | 1.020 | 1.950 - 2.200 | 24 | 2.200 | 5 | | 234100 | |
| | | | 10 | 1.020 | 1.950 - 2.200 | 24 | 2.200 | 5 | | 234090 | |
| | 40 | | 8 | 1.020 | 1.950 - 2.200 | 24 | 2.200 | 5 | | 234101 | |
| | | | 10 | 1.020 | 1.950 - 2.200 | 24 | 2.200 | 5 | | 234091 | |
| | 45 | | 8 | 1.020 | 1.950 - 2.200 | 24 | 2.200 | 5 | | 234102 | |
| | | | 10 | 1.020 | 1.950 - 2.200 | 24 | 2.200 | 5 | | 234092 | |









234142



| 2.2.6.2 Дверной замок Z-TS PT-M с 2 крюками-штырями U-штульп U-6x24x6 K+605 |  |  |  |  |  |  |  |  |  | № | € |
|---|---|---|---|---|---|--|---|---|---|--------|---|
| модуль GM 1020 | 92 | 35 | 8 | 1.020 | 1.800 - 2.000 | 24 | 2.200 | 5 | | 234140 | |
| | | | 10 | 1.020 | 1.800 - 2.000 | 24 | 2.200 | 5 | | 234130 | |
| | 40 | | 8 | 1.020 | 1.800 - 2.000 | 24 | 2.200 | 5 | | 234141 | |
| | | | 10 | 1.020 | 1.800 - 2.000 | 24 | 2.200 | 5 | | 234131 | |
| | 45 | | 8 | 1.020 | 1.800 - 2.000 | 24 | 2.200 | 5 | | 234142 | |
| | | | 10 | 1.020 | 1.800 - 2.000 | 24 | 2.200 | 5 | | 234132 | |







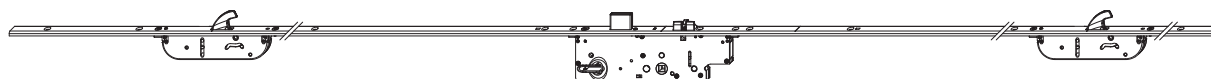

234162



| 2.2.6.3 Дверной замок Z-TS PT-M с 2 крюками-штырями U-штульп U-6x24x6 K+980 |  |  |  |  |  |  |  |  |  | № | € |
|---|---|---|---|---|---|--|---|---|---|--------|---|
| модуль GM 1020 | 92 | 35 | 8 | 1.020 | 2.200 - 2.400 | 24 | 2.200 | 5 | | 234160 | |
| | | | 10 | 1.020 | 2.200 - 2.400 | 24 | 2.200 | 5 | | 234150 | |
| | 40 | | 8 | 1.020 | 2.200 - 2.400 | 24 | 2.200 | 5 | | 234161 | |
| | | | 10 | 1.020 | 2.200 - 2.400 | 24 | 2.200 | 5 | | 234151 | |
| | 45 | | 8 | 1.020 | 2.200 - 2.400 | 24 | 2.200 | 5 | | 234162 | |
| | | | 10 | 1.020 | 2.200 - 2.400 | 24 | 2.200 | 5 | | 234152 | |

237512



| 2.2.6.4 Дверной замок Z-TS PT-M с 2 крюками Штульп U-6x24x6 |  |  |  |  |  |  |  |  |  | № | € |
|---|---|---|---|---|---|--|---|---|---|--------|---|
| модуль GM 1020 | 92 | 35 | 8 | 1.020 | 1.950 - 2.200 | 24 | 2.200 | 5 | | 237510 | |
| | | | 10 | 1.020 | 1.950 - 2.200 | 24 | 2.200 | 5 | | 237500 | |
| | 40 | | 8 | 1.020 | 1.950 - 2.200 | 24 | 2.200 | 5 | | 237511 | |
| | | | 10 | 1.020 | 1.950 - 2.200 | 24 | 2.200 | 5 | | 237501 | |
| | 45 | | 8 | 1.020 | 1.950 - 2.200 | 24 | 2.200 | 5 | | 237512 | |
| | | | 10 | 1.020 | 1.950 - 2.200 | 24 | 2.200 | 5 | | 237502 | |

237552



| 2.2.6.5 Дверной замок Z-TS PT-M с 2 крюками Штульп U-6x24x6 K+605 | | | | | | | L | | № | € |
|---|----|----|-------|---------------|---------------|-------|-------|--------|--------|---|
| модуль GM 1020 | 92 | 35 | 8 | 1.020 | 1.800 - 2.000 | 24 | 2.200 | 5 | 237550 | |
| | | | 10 | 1.020 | 1.800 - 2.000 | 24 | 2.200 | 5 | 237540 | |
| | 40 | 8 | 1.020 | 1.800 - 2.000 | 24 | 2.200 | 5 | 237551 | | |
| | | | 10 | 1.020 | 1.800 - 2.000 | 24 | 2.200 | 5 | 237541 | |
| | 45 | 8 | 1.020 | 1.800 - 2.000 | 24 | 2.200 | 5 | 237552 | | |
| | | | 10 | 1.020 | 1.800 - 2.000 | 24 | 2.200 | 5 | 237542 | |

237572



| 2.2.6.6 Дверной замок Z-TS PT-M с 2 крюками Штульп U-6x24x6 K+980 | | | | | | | L | | № | € |
|---|----|----|-------|---------------|---------------|-------|-------|--------|--------|---|
| модуль GM 1020 | 92 | 35 | 8 | 1.020 | 2.200 - 2.400 | 24 | 2.200 | 5 | 237570 | |
| | | | 10 | 1.020 | 2.200 - 2.400 | 24 | 2.200 | 5 | 237560 | |
| | 40 | 8 | 1.020 | 2.200 - 2.400 | 24 | 2.200 | 5 | 237571 | | |
| | | | 10 | 1.020 | 2.200 - 2.400 | 24 | 2.200 | 5 | 237561 | |
| | 45 | 8 | 1.020 | 2.200 - 2.400 | 24 | 2.200 | 5 | 237572 | | |
| | | | 10 | 1.020 | 2.200 - 2.400 | 24 | 2.200 | 5 | 237562 | |

234692

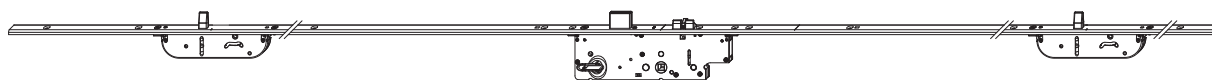

| 2.2.6.7 Дверной замок Z-TS PT-M с 2 штырями Штульп U-6x24x6 | | | | | | | L | | № | € |
|---|----|----|-------|---------------|---------------|-------|-------|--------|--------|---|
| модуль GM 1020 | 92 | 35 | 8 | 1.020 | 1.950 - 2.200 | 24 | 2.200 | 5 | 234690 | |
| | | | 10 | 1.020 | 1.950 - 2.200 | 24 | 2.200 | 5 | 234680 | |
| | 40 | 8 | 1.020 | 1.950 - 2.200 | 24 | 2.200 | 5 | 234691 | | |
| | | | 10 | 1.020 | 1.950 - 2.200 | 24 | 2.200 | 5 | 234681 | |
| | 45 | 8 | 1.020 | 1.950 - 2.200 | 24 | 2.200 | 5 | 234692 | | |
| | | | 10 | 1.020 | 1.950 - 2.200 | 24 | 2.200 | 5 | 234682 | |



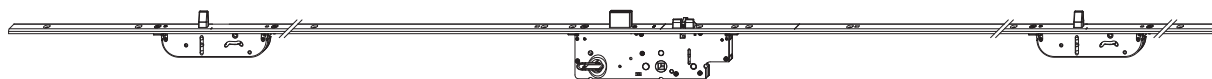



234732



| 2.2.6.8 Дверной замок Z-TS PT-M с 2 штырями Штульп U-6x24x6 K+605 | | | | | | | L | | № | € |
|---|----|----|-------|---------------|---------------|-------|-------|--------|--------|---|
| модуль GM 1020 | 92 | 35 | 8 | 1.020 | 1.800 - 2.000 | 24 | 2.200 | 5 | 234730 | |
| | | | 10 | 1.020 | 1.800 - 2.000 | 24 | 2.200 | 5 | 234720 | |
| | 40 | 8 | 1.020 | 1.800 - 2.000 | 24 | 2.200 | 5 | 234731 | | |
| | | | 10 | 1.020 | 1.800 - 2.000 | 24 | 2.200 | 5 | 234721 | |
| | 45 | 8 | 1.020 | 1.800 - 2.000 | 24 | 2.200 | 5 | 234732 | | |
| | | | 10 | 1.020 | 1.800 - 2.000 | 24 | 2.200 | 5 | 234722 | |







234752



| 2.2.6.9 Дверной замок Z-TS PT-M с 2 штырями Штульп U-6x24x6 K+980 |  |  |  |  |  |  | L |  | № | € |
|---|---|---|---|---|---|--|----------|---|----------|----------|
| модуль GM 1020 | 92 | 35 | 8 | 1.020 | 2.200 - 2.400 | 24 | 2.200 | 5 | 234750 | |
| | | | 10 | 1.020 | 2.200 - 2.400 | 24 | 2.200 | 5 | 234740 | |
| | 40 | 8 | 1.020 | 2.200 - 2.400 | 24 | 2.200 | 5 | 234751 | | |
| | | | 10 | 1.020 | 2.200 - 2.400 | 24 | 2.200 | 5 | 234741 | |
| | 45 | 8 | 1.020 | 2.200 - 2.400 | 24 | 2.200 | 5 | 234752 | | |
| | | | 10 | 1.020 | 2.200 - 2.400 | 24 | 2.200 | 5 | 234742 | |

240262



| 2.2.6.10 Дверной замок Z-TS PT-M с 4 крюками-штырями U-штульп U-6x24x6 |  |  |  |  |  |  | L |  | № | € |
|--|---|---|---|---|---|--|----------|---|----------|----------|
| модуль | 92 | 35 | 8 | 1.020 | 1.950 - 2.200 | 24 | 2.200 | 5 | 240260 | |
| | | | 10 | 1.020 | 1.950 - 2.200 | 24 | 2.200 | 5 | 240270 | |
| | 40 | 8 | 1.020 | 1.950 - 2.200 | 24 | 2.200 | 5 | 240261 | | |
| | | | 10 | 1.020 | 1.950 - 2.200 | 24 | 2.200 | 5 | 240271 | |
| | 45 | 8 | 1.020 | 1.950 - 2.200 | 24 | 2.200 | 5 | 240262 | | |
| | | | 10 | 1.020 | 1.950 - 2.200 | 24 | 2.200 | 5 | 240272 | |

2.3 E92 с дополнительным замком

2.3.1 Штульп F-16 с дополнительным замком

231424

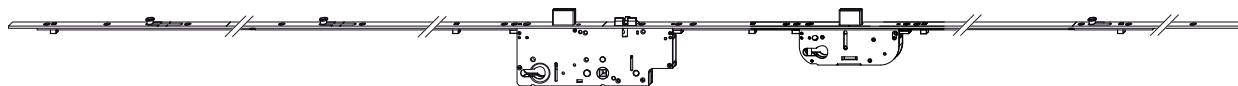

2.3.1.1 Дверной замок Z-TS PT с 3 i.S. цапфами и дополнительным замком Штульп F-16

| | | | | | | | L | | № | € |
|--------|----|----|-------|---------------|---------------|-------|-------|--------|--------|---|
| удлин. | 92 | 35 | 8 | 1.050 | 1.950 - 2.400 | 16 | 2.400 | 5 | 231420 | |
| | | | 10 | 1.050 | 1.950 - 2.400 | 16 | 2.400 | 5 | 231430 | |
| | 40 | 8 | 1.050 | 1.950 - 2.400 | 16 | 2.400 | 5 | 231421 | | |
| | | | 10 | 1.050 | 1.950 - 2.400 | 16 | 2.400 | 5 | 231431 | |
| | 45 | 8 | 1.050 | 1.950 - 2.400 | 16 | 2.400 | 5 | 231422 | | |
| | | | 10 | 1.050 | 1.950 - 2.400 | 16 | 2.400 | 5 | 231432 | |
| | 50 | 8 | 1.050 | 1.950 - 2.400 | 16 | 2.400 | 5 | 231423 | | |
| | | | 10 | 1.050 | 1.950 - 2.400 | 16 | 2.400 | 5 | 231433 | |
| | 55 | 8 | 1.050 | 1.950 - 2.400 | 16 | 2.400 | 5 | 231424 | | |
| | | | 10 | 1.050 | 1.950 - 2.400 | 16 | 2.400 | 5 | 231434 | |
| | 65 | 8 | 1.050 | 1.950 - 2.400 | 16 | 2.400 | 5 | 231425 | | |
| | | | 10 | 1.050 | 1.950 - 2.400 | 16 | 2.400 | 5 | 231435 | |
| | 70 | 8 | 1.050 | 1.950 - 2.400 | 16 | 2.400 | 5 | 231426 | | |
| | | | 10 | 1.050 | 1.950 - 2.400 | 16 | 2.400 | 5 | 231436 | |
| | 80 | 8 | 1.050 | 1.950 - 2.400 | 16 | 2.400 | 5 | 231427 | | |
| | | | 10 | 1.050 | 1.950 - 2.400 | 16 | 2.400 | 5 | 231437 | |

234044















2.3.1.2 Дверной замок Z-TS PT-M с 2 крюками-штырями и дополнительным замком Штульп F-16

| | | | | | | | L | | № | € |
|--------|----|----|-------|---------------|---------------|-------|-------|--------|--------|---|
| модуль | 92 | 35 | 8 | 1.050 | 1.950 - 2.400 | 16 | 2.400 | 5 | 234040 | |
| | | | 10 | 1.050 | 1.950 - 2.400 | 16 | 2.400 | 5 | 234030 | |
| | 40 | 8 | 1.050 | 1.950 - 2.400 | 16 | 2.400 | 5 | 234041 | | |
| | | | 10 | 1.050 | 1.950 - 2.400 | 16 | 2.400 | 5 | 234031 | |
| | 45 | 8 | 1.050 | 1.950 - 2.400 | 16 | 2.400 | 5 | 234042 | | |
| | | | 10 | 1.050 | 1.950 - 2.400 | 16 | 2.400 | 5 | 234032 | |
| | 50 | 8 | 1.050 | 1.950 - 2.400 | 16 | 2.400 | 5 | 234043 | | |
| | | | 10 | 1.050 | 1.950 - 2.400 | 16 | 2.400 | 5 | 234033 | |
| | 55 | 8 | 1.050 | 1.950 - 2.400 | 16 | 2.400 | 5 | 234044 | | |
| | | | 10 | 1.050 | 1.950 - 2.400 | 16 | 2.400 | 5 | 234034 | |
| | 65 | 8 | 1.050 | 1.950 - 2.400 | 16 | 2.400 | 5 | 234045 | | |
| | | | 10 | 1.050 | 1.950 - 2.400 | 16 | 2.400 | 5 | 234035 | |
| | 70 | 8 | 1.050 | 1.950 - 2.400 | 16 | 2.400 | 5 | 234046 | | |
| | | | 10 | 1.050 | 1.950 - 2.400 | 16 | 2.400 | 5 | 234036 | |
| | 80 | 8 | 1.050 | 1.950 - 2.400 | 16 | 2.400 | 5 | 234047 | | |
| | | | 10 | 1.050 | 1.950 - 2.400 | 16 | 2.400 | 5 | 234037 | |









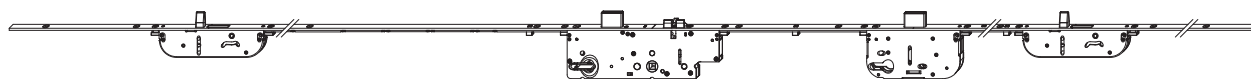



234624



| 2.3.1.3 Дверной замок Z-TS PT-M с 2 крюками и дополнительным замком Штульп F-16 | |  |  |  |  |  |  |  |  |  |  |  |  |
|---|----|---|---|---|---|---|--|---|---|---|---|---|---|
| модуль | 92 | 35 | 8 | 1.050 | 1.950 - 2.400 | 16 | 2.400 | 5 | 234620 | € | | | |
| | | 10 | 1.050 | 1.950 - 2.400 | 16 | 2.400 | 5 | 234290 | | | | | |
| | 40 | 8 | 1.050 | 1.950 - 2.400 | 16 | 2.400 | 5 | 234621 | | | | | |
| | | 10 | 1.050 | 1.950 - 2.400 | 16 | 2.400 | 5 | 234291 | | | | | |
| | 45 | 8 | 1.050 | 1.950 - 2.400 | 16 | 2.400 | 5 | 234622 | | | | | |
| | | 10 | 1.050 | 1.950 - 2.400 | 16 | 2.400 | 5 | 234292 | | | | | |
| | 50 | 8 | 1.050 | 1.950 - 2.400 | 16 | 2.400 | 5 | 234623 | | | | | |
| | | 10 | 1.050 | 1.950 - 2.400 | 16 | 2.400 | 5 | 234293 | | | | | |
| | 55 | 8 | 1.050 | 1.950 - 2.400 | 16 | 2.400 | 5 | 234624 | | | | | |
| | | 10 | 1.050 | 1.950 - 2.400 | 16 | 2.400 | 5 | 234294 | | | | | |
| | 65 | 8 | 1.050 | 1.950 - 2.400 | 16 | 2.400 | 5 | 234625 | | | | | |
| | | 10 | 1.050 | 1.950 - 2.400 | 16 | 2.400 | 5 | 234295 | | | | | |
| | 70 | 8 | 1.050 | 1.950 - 2.400 | 16 | 2.400 | 5 | 234626 | | | | | |
| | | 10 | 1.050 | 1.950 - 2.400 | 16 | 2.400 | 5 | 234296 | | | | | |
| | 80 | 8 | 1.050 | 1.950 - 2.400 | 16 | 2.400 | 5 | 234627 | | | | | |
| | | 10 | 1.050 | 1.950 - 2.400 | 16 | 2.400 | 5 | 234297 | | | | | |

234614



| 2.3.1.4 Дверной замок Z-TS PT-M с 2 штырями и дополнительным замком Штульп F-16 | |  |  |  |  |  |  |  |  |  |  |  |  |
|---|----|---|---|---|---|---|--|---|---|---|---|---|---|
| модуль | 92 | 35 | 8 | 1.050 | 1.950 - 2.400 | 16 | 2.400 | 5 | 234610 | € | | | |
| | | 10 | 1.050 | 1.950 - 2.400 | 16 | 2.400 | 5 | 234470 | | | | | |
| | 40 | 8 | 1.050 | 1.950 - 2.400 | 16 | 2.400 | 5 | 234611 | | | | | |
| | | 10 | 1.050 | 1.950 - 2.400 | 16 | 2.400 | 5 | 234471 | | | | | |
| | 45 | 8 | 1.050 | 1.950 - 2.400 | 16 | 2.400 | 5 | 234612 | | | | | |
| | | 10 | 1.050 | 1.950 - 2.400 | 16 | 2.400 | 5 | 234472 | | | | | |
| | 50 | 8 | 1.050 | 1.950 - 2.400 | 16 | 2.400 | 5 | 234613 | | | | | |
| | | 10 | 1.050 | 1.950 - 2.400 | 16 | 2.400 | 5 | 234473 | | | | | |
| | 55 | 8 | 1.050 | 1.950 - 2.400 | 16 | 2.400 | 5 | 234614 | | | | | |
| | | 10 | 1.050 | 1.950 - 2.400 | 16 | 2.400 | 5 | 234474 | | | | | |
| | 65 | 8 | 1.050 | 1.950 - 2.400 | 16 | 2.400 | 5 | 234615 | | | | | |
| | | 10 | 1.050 | 1.950 - 2.400 | 16 | 2.400 | 5 | 234475 | | | | | |
| | 70 | 8 | 1.050 | 1.950 - 2.400 | 16 | 2.400 | 5 | 234616 | | | | | |
| | | 10 | 1.050 | 1.950 - 2.400 | 16 | 2.400 | 5 | 234476 | | | | | |
| | 80 | 8 | 1.050 | 1.950 - 2.400 | 16 | 2.400 | 5 | 234617 | | | | | |
| | | 10 | 1.050 | 1.950 - 2.400 | 16 | 2.400 | 5 | 234477 | | | | | |

2.3.2 Штульп F-20 с дополнительным замком

231464

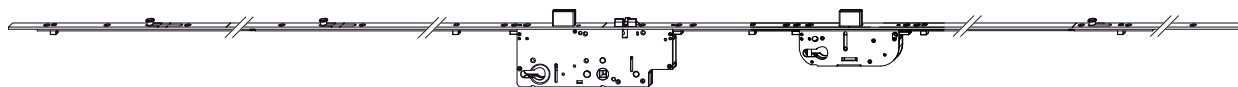

2.3.2.1 Дверной замок Z-TS PT с 3 i.S. цапфами и дополнительным замком Штульп F-20



№

€

удлин.

| 92 | 35 | 8 | 1.050 | 1.950 - 2.400 | 20 | 2.400 | 5 | № | € |
|----|----|----|-------|---------------|----|-------|---|--------|---|
| | | 10 | 1.050 | 1.950 - 2.400 | 20 | 2.400 | 5 | 231460 | |
| | 40 | 8 | 1.050 | 1.950 - 2.400 | 20 | 2.400 | 5 | 231461 | |
| | | 10 | 1.050 | 1.950 - 2.400 | 20 | 2.400 | 5 | 231471 | |
| | 45 | 8 | 1.050 | 1.950 - 2.400 | 20 | 2.400 | 5 | 231462 | |
| | | 10 | 1.050 | 1.950 - 2.400 | 20 | 2.400 | 5 | 231472 | |
| | 50 | 8 | 1.050 | 1.950 - 2.400 | 20 | 2.400 | 5 | 231463 | |
| | | 10 | 1.050 | 1.950 - 2.400 | 20 | 2.400 | 5 | 231473 | |
| | 55 | 8 | 1.050 | 1.950 - 2.400 | 20 | 2.400 | 5 | 231464 | |
| | | 10 | 1.050 | 1.950 - 2.400 | 20 | 2.400 | 5 | 231474 | |
| | 65 | 8 | 1.050 | 1.950 - 2.400 | 20 | 2.400 | 5 | 231465 | |
| | | 10 | 1.050 | 1.950 - 2.400 | 20 | 2.400 | 5 | 231475 | |
| | 70 | 8 | 1.050 | 1.950 - 2.400 | 20 | 2.400 | 5 | 231466 | |
| | | 10 | 1.050 | 1.950 - 2.400 | 20 | 2.400 | 5 | 231476 | |
| | 80 | 8 | 1.050 | 1.950 - 2.400 | 20 | 2.400 | 5 | 231467 | |
| | | 10 | 1.050 | 1.950 - 2.400 | 20 | 2.400 | 5 | 231477 | |

235164

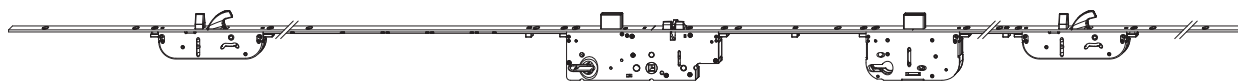

2.3.2.2 Дверной замок Z-TS PT-M с 2 крюками-штырями и дополнительным замком Штульп F-20



№







€

модуль

| 92 | 35 | 8 | 1.050 | 1.950 - 2.400 | 20 | 2.400 | 5 | № | € |
|----|----|----|-------|---------------|----|-------|---|--------|---|
| | | 10 | 1.050 | 1.950 - 2.400 | 20 | 2.400 | 5 | 235160 | |
| | 40 | 8 | 1.050 | 1.950 - 2.400 | 20 | 2.400 | 5 | 235161 | |
| | | 10 | 1.050 | 1.950 - 2.400 | 20 | 2.400 | 5 | 235151 | |
| | 45 | 8 | 1.050 | 1.950 - 2.400 | 20 | 2.400 | 5 | 235162 | |
| | | 10 | 1.050 | 1.950 - 2.400 | 20 | 2.400 | 5 | 235152 | |
| | 50 | 8 | 1.050 | 1.950 - 2.400 | 20 | 2.400 | 5 | 235163 | |
| | | 10 | 1.050 | 1.950 - 2.400 | 20 | 2.400 | 5 | 235153 | |
| | 55 | 8 | 1.050 | 1.950 - 2.400 | 20 | 2.400 | 5 | 235164 | |
| | | 10 | 1.050 | 1.950 - 2.400 | 20 | 2.400 | 5 | 235154 | |
| | 65 | 8 | 1.050 | 1.950 - 2.400 | 20 | 2.400 | 5 | 235165 | |
| | | 10 | 1.050 | 1.950 - 2.400 | 20 | 2.400 | 5 | 235155 | |
| | 70 | 8 | 1.050 | 1.950 - 2.400 | 20 | 2.400 | 5 | 235166 | |
| | | 10 | 1.050 | 1.950 - 2.400 | 20 | 2.400 | 5 | 235156 | |
| | 80 | 8 | 1.050 | 1.950 - 2.400 | 20 | 2.400 | 5 | 235167 | |
| | | 10 | 1.050 | 1.950 - 2.400 | 20 | 2.400 | 5 | 235157 | |







234344

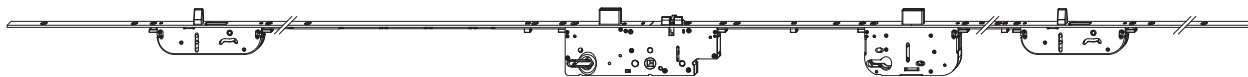

| 2.3.2.3 Дверной замок Z-TS PT-M с 2 крюками и дополнительным замком Штульп F-20 | |  |  |  |  |  |  |  | № | € |
|--|----|---|---|---|---|--|---|---|---------------|----------|
| модуль | 92 | 35 | 8 | 1.050 | 1.950 - 2.400 | 20 | 2.400 | 5 | 234340 | |
| | | 10 | 1.050 | 1.950 - 2.400 | 20 | 2.400 | 5 | 234350 | | |
| | 40 | 8 | 1.050 | 1.950 - 2.400 | 20 | 2.400 | 5 | 234341 | | |
| | | 10 | 1.050 | 1.950 - 2.400 | 20 | 2.400 | 5 | 234351 | | |
| | 45 | 8 | 1.050 | 1.950 - 2.400 | 20 | 2.400 | 5 | 234342 | | |
| | | 10 | 1.050 | 1.950 - 2.400 | 20 | 2.400 | 5 | 234352 | | |
| | 50 | 8 | 1.050 | 1.950 - 2.400 | 20 | 2.400 | 5 | 234343 | | |
| | | 10 | 1.050 | 1.950 - 2.400 | 20 | 2.400 | 5 | 234353 | | |
| | 55 | 8 | 1.050 | 1.950 - 2.400 | 20 | 2.400 | 5 | 234344 | | |
| | | 10 | 1.050 | 1.950 - 2.400 | 20 | 2.400 | 5 | 234354 | | |
| | 65 | 8 | 1.050 | 1.950 - 2.400 | 20 | 2.400 | 5 | 234345 | | |
| | | 10 | 1.050 | 1.950 - 2.400 | 20 | 2.400 | 5 | 234355 | | |
| | 70 | 8 | 1.050 | 1.950 - 2.400 | 20 | 2.400 | 5 | 234346 | | |
| | | 10 | 1.050 | 1.950 - 2.400 | 20 | 2.400 | 5 | 234356 | | |
| | 80 | 8 | 1.050 | 1.950 - 2.400 | 20 | 2.400 | 5 | 234347 | | |
| | | 10 | 1.050 | 1.950 - 2.400 | 20 | 2.400 | 5 | 234357 | | |

234524



| 2.3.2.4 Дверной замок Z-TS PT-M с 2 штырями и дополнительным замком Штульп F-20 | |  |  |  |  |  |  |  | № | € |
|--|----|---|---|---|---|--|---|---|---------------|----------|
| модуль | 92 | 35 | 8 | 1.050 | 1.950 - 2.400 | 20 | 2.400 | 5 | 234520 | |
| | | 10 | 1.050 | 1.950 - 2.400 | 20 | 2.400 | 5 | 234530 | | |
| | 40 | 8 | 1.050 | 1.950 - 2.400 | 20 | 2.400 | 5 | 234521 | | |
| | | 10 | 1.050 | 1.950 - 2.400 | 20 | 2.400 | 5 | 234531 | | |
| | 45 | 8 | 1.050 | 1.950 - 2.400 | 20 | 2.400 | 5 | 234522 | | |
| | | 10 | 1.050 | 1.950 - 2.400 | 20 | 2.400 | 5 | 234532 | | |
| | 50 | 8 | 1.050 | 1.950 - 2.400 | 20 | 2.400 | 5 | 234523 | | |
| | | 10 | 1.050 | 1.950 - 2.400 | 20 | 2.400 | 5 | 234533 | | |
| | 55 | 8 | 1.050 | 1.950 - 2.400 | 20 | 2.400 | 5 | 234524 | | |
| | | 10 | 1.050 | 1.950 - 2.400 | 20 | 2.400 | 5 | 234534 | | |
| | 65 | 8 | 1.050 | 1.950 - 2.400 | 20 | 2.400 | 5 | 234525 | | |
| | | 10 | 1.050 | 1.950 - 2.400 | 20 | 2.400 | 5 | 234535 | | |
| | 70 | 8 | 1.050 | 1.950 - 2.400 | 20 | 2.400 | 5 | 234526 | | |
| | | 10 | 1.050 | 1.950 - 2.400 | 20 | 2.400 | 5 | 234536 | | |
| | 80 | 8 | 1.050 | 1.950 - 2.400 | 20 | 2.400 | 5 | 234527 | | |
| | | 10 | 1.050 | 1.950 - 2.400 | 20 | 2.400 | 5 | 234537 | | |

2.4 E88

2.4.1 Штульп F-16

230014

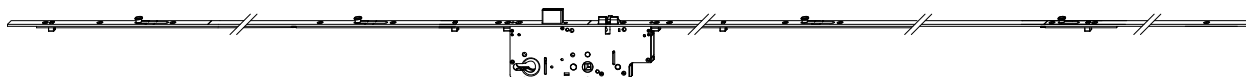

2.4.1.1 Дверной замок Z-TS PT
с 4 i.S. цапфами Штульп F-16



№

€

| удлин. | 88 | 35 | 8,5 | 1.050 | 1.950 - 2.400 | 16 | 2.400 | 5 | № | € |
|--------|----|----|-----|-------|---------------|----|-------|---|--------|---|
| | | 40 | 8,5 | 1.050 | 1.950 - 2.400 | 16 | 2.400 | 5 | 230011 | |
| | | 45 | 8,5 | 1.050 | 1.950 - 2.400 | 16 | 2.400 | 5 | 230012 | |
| | | 50 | 8,5 | 1.050 | 1.950 - 2.400 | 16 | 2.400 | 5 | 230013 | |
| | | 55 | 8,5 | 1.050 | 1.950 - 2.400 | 16 | 2.400 | 5 | 230014 | |
| | | 65 | 8,5 | 1.050 | 1.950 - 2.400 | 16 | 2.400 | 5 | 230015 | |
| | | 70 | 8,5 | 1.050 | 1.950 - 2.400 | 16 | 2.400 | 5 | 230016 | |
| | | 80 | 8,5 | 1.050 | 1.950 - 2.400 | 16 | 2.400 | 5 | 230017 | |

235804



2.4.1.2 Дверной замок Z-TS PT-M
с 2 крюками-штырями
Штульп F-16



№

€

| модуль | 88 | 35 | 8,5 | 1.050 | 1.950 - 2.400 | 16 | 2.400 | 5 | № | € |
|--------|----|----|-----|-------|---------------|----|-------|---|--------|---|
| | | 40 | 8,5 | 1.050 | 1.950 - 2.400 | 16 | 2.400 | 5 | 235801 | |
| | | 45 | 8,5 | 1.050 | 1.950 - 2.400 | 16 | 2.400 | 5 | 235802 | |
| | | 50 | 8,5 | 1.050 | 1.950 - 2.400 | 16 | 2.400 | 5 | 235803 | |
| | | 55 | 8,5 | 1.050 | 1.950 - 2.400 | 16 | 2.400 | 5 | 235804 | |
| | | 65 | 8,5 | 1.050 | 1.950 - 2.400 | 16 | 2.400 | 5 | 235805 | |
| | | 70 | 8,5 | 1.050 | 1.950 - 2.400 | 16 | 2.400 | 5 | 235806 | |
| | | 80 | 8,5 | 1.050 | 1.950 - 2.400 | 16 | 2.400 | 5 | 235807 | |

234274



2.4.1.3 Дверной замок Z-TS PT-M
с 2 крюками Штульп F-16









№

€

| модуль | 88 | 35 | 8,5 | 1.050 | 1.950 - 2.400 | 16 | 2.400 | 5 | № | € |
|--------|----|----|-----|-------|---------------|----|-------|---|--------|---|
| | | 40 | 8,5 | 1.050 | 1.950 - 2.400 | 16 | 2.400 | 5 | 234271 | |
| | | 45 | 8,5 | 1.050 | 1.950 - 2.400 | 16 | 2.400 | 5 | 234272 | |
| | | 50 | 8,5 | 1.050 | 1.950 - 2.400 | 16 | 2.400 | 5 | 234273 | |
| | | 55 | 8,5 | 1.050 | 1.950 - 2.400 | 16 | 2.400 | 5 | 234274 | |
| | | 65 | 8,5 | 1.050 | 1.950 - 2.400 | 16 | 2.400 | 5 | 234275 | |
| | | 70 | 8,5 | 1.050 | 1.950 - 2.400 | 16 | 2.400 | 5 | 234276 | |
| | | 80 | 8,5 | 1.050 | 1.950 - 2.400 | 16 | 2.400 | 5 | 234277 | |







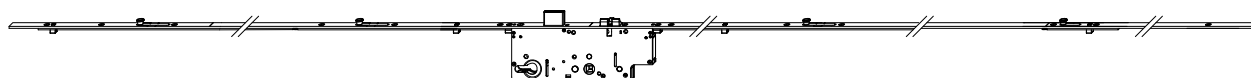

234434

| 2.4.1.4 Дверной замок Z-TS PT-M с 2 штырями Штульп F-16 |  |  |  |  |  |  | L |  | № | € |
|---|---|---|---|---|---|--|-------|---|--------|---|
| модуль | 88 | 35 | 8,5 | 1.050 | 1.950 - 2.400 | 16 | 2.400 | 5 | 234430 | |
| | 40 | 8,5 | 1.050 | 1.950 - 2.400 | 16 | 2.400 | 5 | 234431 | | |
| | 45 | 8,5 | 1.050 | 1.950 - 2.400 | 16 | 2.400 | 5 | 234432 | | |
| | 50 | 8,5 | 1.050 | 1.950 - 2.400 | 16 | 2.400 | 5 | 234433 | | |
| | 55 | 8,5 | 1.050 | 1.950 - 2.400 | 16 | 2.400 | 5 | 234434 | | |
| | 65 | 8,5 | 1.050 | 1.950 - 2.400 | 16 | 2.400 | 5 | 234435 | | |
| | 70 | 8,5 | 1.050 | 1.950 - 2.400 | 16 | 2.400 | 5 | 234436 | | |
| | 80 | 8,5 | 1.050 | 1.950 - 2.400 | 16 | 2.400 | 5 | 234437 | | |

2.4.2 Штульп F-20









230254

| 2.4.2.1 Дверной замок Z-TS PT с 4 i.S. цапфами Штульп F-20 |  |  |  |  |  |  | L |  | № | € |
|--|---|---|---|---|---|--|-------|---|--------|---|
| удлин. | 88 | 35 | 8,5 | 1.050 | 1.950 - 2.400 | 20 | 2.400 | 5 | 230250 | |
| | 40 | 8,5 | 1.050 | 1.950 - 2.400 | 20 | 2.400 | 5 | 230251 | | |
| | 45 | 8,5 | 1.050 | 1.950 - 2.400 | 20 | 2.400 | 5 | 230252 | | |
| | 50 | 8,5 | 1.050 | 1.950 - 2.400 | 20 | 2.400 | 5 | 230253 | | |
| | 55 | 8,5 | 1.050 | 1.950 - 2.400 | 20 | 2.400 | 5 | 230254 | | |
| | 65 | 8,5 | 1.050 | 1.950 - 2.400 | 20 | 2.400 | 5 | 230255 | | |
| | 70 | 8,5 | 1.050 | 1.950 - 2.400 | 20 | 2.400 | 5 | 230256 | | |
| | 80 | 8,5 | 1.050 | 1.950 - 2.400 | 20 | 2.400 | 5 | 230257 | | |



235844

| 2.4.2.2 Дверной замок Z-TS PT-M с 2 крюками-штырями Штульп F-20 |  |  |  |  |  |  | L |  | № | € |
|---|---|---|---|---|---|--|-------|---|--------|---|
| модуль | 88 | 35 | 8,5 | 1.050 | 1.950 - 2.400 | 20 | 2.400 | 5 | 235840 | |
| | 40 | 8,5 | 1.050 | 1.950 - 2.400 | 20 | 2.400 | 5 | 235841 | | |
| | 45 | 8,5 | 1.050 | 1.950 - 2.400 | 20 | 2.400 | 5 | 235842 | | |
| | 50 | 8,5 | 1.050 | 1.950 - 2.400 | 20 | 2.400 | 5 | 235843 | | |
| | 55 | 8,5 | 1.050 | 1.950 - 2.400 | 20 | 2.400 | 5 | 235844 | | |
| | 65 | 8,5 | 1.050 | 1.950 - 2.400 | 20 | 2.400 | 5 | 235845 | | |
| | 70 | 8,5 | 1.050 | 1.950 - 2.400 | 20 | 2.400 | 5 | 235846 | | |
| | 80 | 8,5 | 1.050 | 1.950 - 2.400 | 20 | 2.400 | 5 | 235847 | | |

234314



2.4.2.3 Дверной замок Z-TS PT-M с 2 крюками Штульп F-20



№

€

| модуль | 88 | 35 | 8,5 | 1.050 | 1.950 - 2.400 | 20 | 2.400 | 5 | № | € |
|--------|----|----|-----|-------|---------------|----|-------|---|---------------|----------|
| | | 40 | 8,5 | 1.050 | 1.950 - 2.400 | 20 | 2.400 | 5 | 234310 | |
| | | 45 | 8,5 | 1.050 | 1.950 - 2.400 | 20 | 2.400 | 5 | 234311 | |
| | | 50 | 8,5 | 1.050 | 1.950 - 2.400 | 20 | 2.400 | 5 | 234312 | |
| | | 55 | 8,5 | 1.050 | 1.950 - 2.400 | 20 | 2.400 | 5 | 234313 | |
| | | 65 | 8,5 | 1.050 | 1.950 - 2.400 | 20 | 2.400 | 5 | 234314 | |
| | | 70 | 8,5 | 1.050 | 1.950 - 2.400 | 20 | 2.400 | 5 | 234315 | |
| | | 80 | 8,5 | 1.050 | 1.950 - 2.400 | 20 | 2.400 | 5 | 234316 | |

234494



2.4.2.4 Дверной замок Z-TS PT-M с 2 штырями Штульп F-20



№



€

| модуль | 88 | 35 | 8,5 | 1.050 | 1.950 - 2.400 | 20 | 2.400 | 5 | № | € |
|--------|----|----|-----|-------|---------------|----|-------|---|---------------|----------|
| | | 40 | 8,5 | 1.050 | 1.950 - 2.400 | 20 | 2.400 | 5 | 234490 | |
| | | 45 | 8,5 | 1.050 | 1.950 - 2.400 | 20 | 2.400 | 5 | 234491 | |
| | | 50 | 8,5 | 1.050 | 1.950 - 2.400 | 20 | 2.400 | 5 | 234492 | |
| | | 55 | 8,5 | 1.050 | 1.950 - 2.400 | 20 | 2.400 | 5 | 234493 | |
| | | 65 | 8,5 | 1.050 | 1.950 - 2.400 | 20 | 2.400 | 5 | 234494 | |
| | | 70 | 8,5 | 1.050 | 1.950 - 2.400 | 20 | 2.400 | 5 | 234495 | |
| | | 80 | 8,5 | 1.050 | 1.950 - 2.400 | 20 | 2.400 | 5 | 234496 | |



2

2.5 Принадлежности для замков Modul



102219 

| 2.5.1 Удлинительный шульп | |  | L |  | № | € |
|---------------------------|---------|---|-----|---|--------|---|
| Удлиняющий шульп . | L | 16 | 250 | 10 | 102219 | |
| | | 20 | 250 | 10 | 102555 | |
| | | 24 | 250 | 10 | 102745 | |
| | | 24/16 | 250 | 10 | 102929 | |
| | U-шульп | 24 | 250 | 10 | 103059 | |



102556 

| 2.5.2 Укорачивающий шульп | |  | L |  | № | € |
|---------------------------|---------|---|----|---|--------|---|
| Укорач. шульп . | L | 16 | 50 | 10 | 102556 | |
| | | 20 | 50 | 10 | 102557 | |
| | | 24 | 50 | 10 | 103062 | |
| | | 24/16 | 50 | 10 | 102930 | |
| | U-шульп | 24 | 50 | 20 | 103058 | |

212761 



| 2.5.3 Модульный шульп с магнитными цапфами | |  | L |  | № | € |
|--|---------|---|-----|---|--------|---|
| Шульп модуля с контактным датчиком . | L | 16 | 350 | 5 | 212646 | |
| | | 20 | 350 | 5 | 212761 | |
| | | 24 | 350 | 5 | 212765 | |
| | | 24/16 | 350 | 5 | 213964 | |
| | U-шульп | 24 | 350 | 5 | 215380 | |

212644 

| 2.5.4 Модульный шульп с крюками-штырями | |  | L |  | № | € |
|---|---------|---|-----|---|--------|---|
| Модуль шульпа с крюком . | U-шульп | 24 | 350 | 5 | 215397 | |
| Модуль шульпа со штырем . | U-шульп | 24 | 350 | 5 | 215398 | |
| Шульп модуля с крюком-штырем . | L | 16 | 350 | 5 | 212644 | |
| | | 20 | 350 | 5 | 212759 | |
| | | 24 | 350 | 5 | 212763 | |
| | | 24/16 | 350 | 5 | 213962 | |
| | U-шульп | 24 | 350 | 5 | 215377 | |

212645



| 2.5.5 Модульный шульп с дополнительным замком |  |  | L |  | № | € | | |
|---|---|---|---------|---|-----|--------|--------|--|
| Шульп модуля с доп. замком . | L | 16 | 35 | 350 | 5 | 212645 | | |
| | | | 40 | 350 | 5 | 212773 | | |
| | | | 45 | 350 | 5 | 212774 | | |
| | | | 50 | 350 | 5 | 212775 | | |
| | | | 55 | 350 | 5 | 212776 | | |
| | | | 65 | 350 | 5 | 212778 | | |
| | | | 20 | 35 | 350 | 5 | 212760 | |
| | | | | 40 | 350 | 5 | 212889 | |
| | | | | 45 | 350 | 5 | 212890 | |
| | | | | 50 | 350 | 5 | 212891 | |
| | | | | 55 | 350 | 5 | 212892 | |
| | | | 24 | 65 | 350 | 5 | 212894 | |
| | | | | 35 | 350 | 5 | 212764 | |
| | | | | 40 | 350 | 5 | 212895 | |
| | | | | 45 | 350 | 5 | 212896 | |
| | | | | 50 | 350 | 5 | 212897 | |
| | | | 24/16 | 55 | 350 | 5 | 212898 | |
| | | | | 65 | 350 | 5 | 212900 | |
| | | | | 35 | 350 | 5 | 213963 | |
| | | | | 40 | 350 | 5 | 213965 | |
| | | | | 45 | 350 | 5 | 213966 | |
| | | | U-шульп | 50 | 350 | 5 | 213967 | |
| | | | | 55 | 350 | 5 | 213968 | |
| | | | | 65 | 350 | 5 | 213969 | |
| | | | | 35 | 350 | 5 | 215378 | |
| | | | | 45 | 350 | 5 | 215379 | |

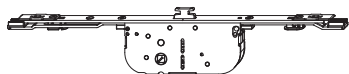

213046



| 2.5.6 Модульный шульп с ограничителем открывания |  |  | L |  | № | € | | |
|--|---|---|---------|---|-----|--------|--------|--|
| Шульп модуля с огран. открыв. . | L | 16 | 35 | 350 | 5 | 213046 | | |
| | | | 40 | 350 | 5 | 213047 | | |
| | | | 45 | 350 | 5 | 213048 | | |
| | | | 50 | 350 | 5 | 213049 | | |
| | | | 55 | 350 | 5 | 213050 | | |
| | | | 65 | 350 | 5 | 213051 | | |
| | | | 20 | 35 | 350 | 5 | 213054 | |
| | | | | 40 | 350 | 5 | 213055 | |
| | | | | 45 | 350 | 5 | 213056 | |
| | | | | 50 | 350 | 5 | 213057 | |
| | | | | 55 | 350 | 5 | 213058 | |
| | | | 24 | 65 | 350 | 5 | 213059 | |
| | | | | 35 | 350 | 5 | 213062 | |
| | | | | 40 | 350 | 5 | 213063 | |
| | | | | 45 | 350 | 5 | 213064 | |
| | | | | 50 | 350 | 5 | 213065 | |
| | | | 24/16 | 55 | 350 | 5 | 213066 | |
| | | | | 65 | 350 | 5 | 213067 | |
| | | | | 35 | 350 | 5 | 214030 | |
| | | | | 40 | 350 | 5 | 214031 | |
| | | | | 45 | 350 | 5 | 214032 | |
| | | | U-шульп | 50 | 350 | 5 | 214033 | |
| | | | | 55 | 350 | 5 | 214034 | |
| | | | | 65 | 350 | 5 | 214035 | |
| | | | | 35 | 350 | 5 | 215381 | |
| | | | | 45 | 350 | 5 | 215382 | |

212643



| 2.5.7 Прмежуточный шульп | |  | L |  | № | € |
|---------------------------------|---|---|-----|---|--------|--------|
| Промеж. шульп . | L | 16 | 705 | 5 | 212643 | |
| | | 20 | 705 | 5 | 212758 | |
| | | 24 | 705 | 5 | 212762 | |
| | | 24/16 | 705 | 5 | 213961 | |
| | | U-шульп | 24 | 705 | 5 | 215376 |
| Промежуточный шульп со штырем . | L | 16 | 705 | 5 | 215098 | |
| | | 20 | 705 | 5 | 215099 | |
| | | 24 | 705 | 5 | 215100 | |
| | | 24/16 | 705 | 5 | 215101 | |
| | | U-шульп | 24 | 705 | 5 | 215396 |
| Промежуточный шульп с крюком . | L | 16 | 705 | 5 | 215102 | |
| | | 20 | 705 | 5 | 215103 | |
| | | 24 | 705 | 5 | 215104 | |
| | | 24/16 | 705 | 5 | 215105 | |
| | | U-шульп | 24 | 705 | 5 | 215395 |

203784

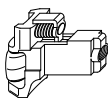

| 2.6 | Роликовая защёлка для замка Z-TS PT-M |  | № | € |
|-------|---------------------------------------|---|--------|---|
| DM 35 | | 10 | 203784 | |
| 40 | | 10 | 203785 | |
| 45 | | 10 | 203786 | |
| 50 | | 10 | 203787 | |
| 55 | | 10 | 203788 | |
| 65 | | 10 | 203790 | |
| 70 | | 10 | 203791 | |
| 80 | | 10 | 203792 | |

101555



| 2.7 | Сменная фалевая защёлка для замка Z-TS PT-M |  | № | € |
|-------|---|---|--------|---|
| DM 35 | | 10 | 101555 | |
| 40 | | 10 | 101556 | |
| 45 | | 10 | 101553 | |
| 50 | | 10 | 101557 | |
| 55 | | 10 | 101477 | |
| 65 | | 10 | 101558 | |
| 70 | | 10 | 101559 | |
| 80 | | 10 | 101560 | |

362906



| 2.8 | Пластиковая клипса фалевой защёлки |  | № | € |
|------------------------------------|------------------------------------|---|--------|---|
| Клипса фалевой защёлки | | 50 | 43586 | |
| Клипса для съёмной фалевой защёлки | | 100 | 362906 | |

**MACO
PROTECT**



Дверные замки Z-TS Modul PT



3 Дверные замки Z-TF PT

| | | |
|-----|---|----|
| 3.1 | Монтажная схема замка Z-TF PT с i.S. цапфами _____ | 56 |
| 3.2 | Дверной замок Z-TF i.S. PT _____ | 59 |
| 3.3 | Монтажная схема замка Z-TF PT с i.S. цапфами WK2 _____ | 64 |
| 3.4 | Дверной замок Z-TF i.S. PT с возможностью WK2 _____ | 68 |
| 3.5 | Монтажная схема замка Z-TF PT 2 фалевые защёлки - штыри _____ | 72 |
| 3.6 | Замок Z-TF PT с фалевыми защёлками-штырями _____ | 75 |

3 Дверные замки Z-TF PT

3.1 Монтажная схема замка Z-TF PT с i.S. цапфами

2 фалевые защёлки + 2 i.S. цапфы
1 и 2 - створчатые

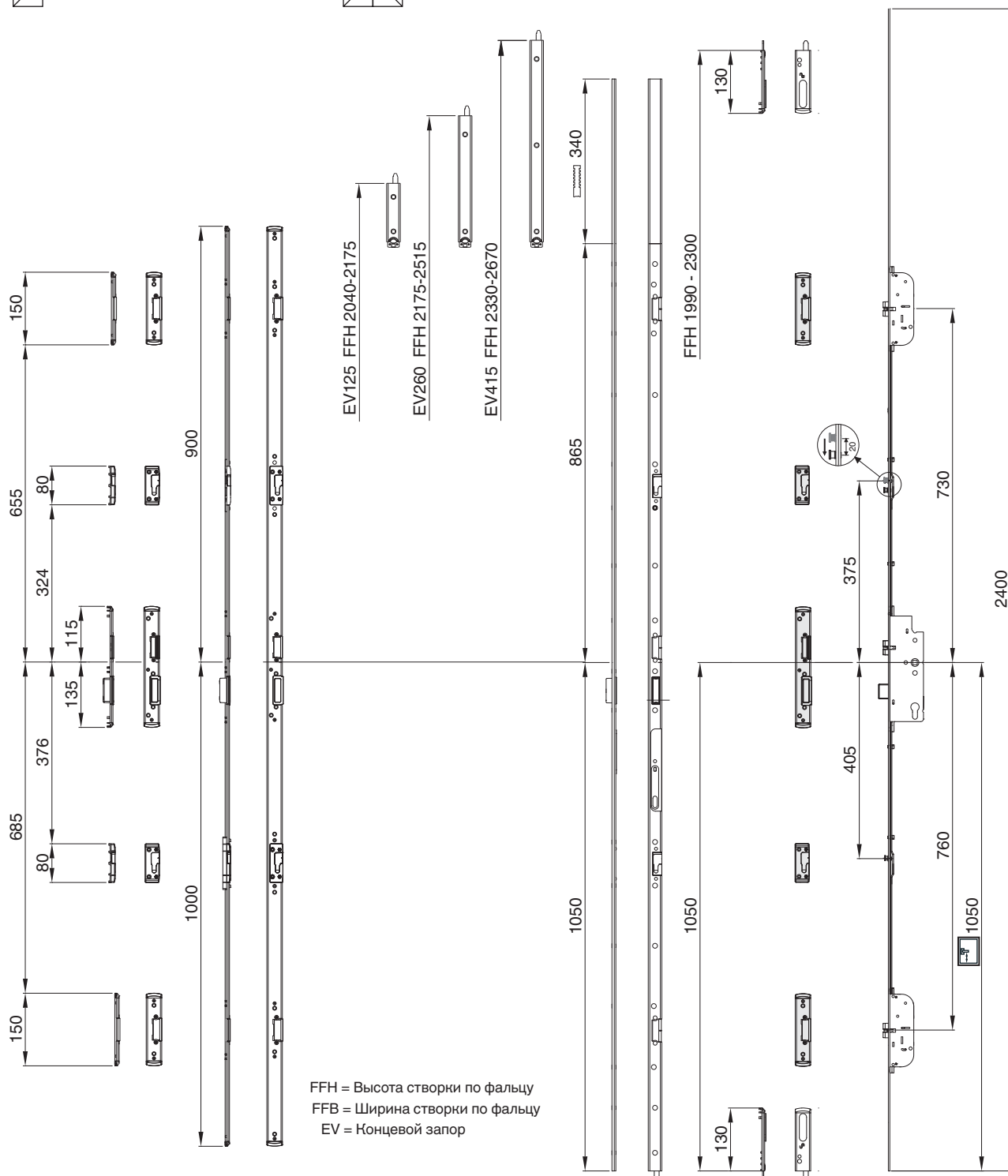



2 фалевые защёлки + 2 i.S. цапфы K+500
1 и 2 - створчатые

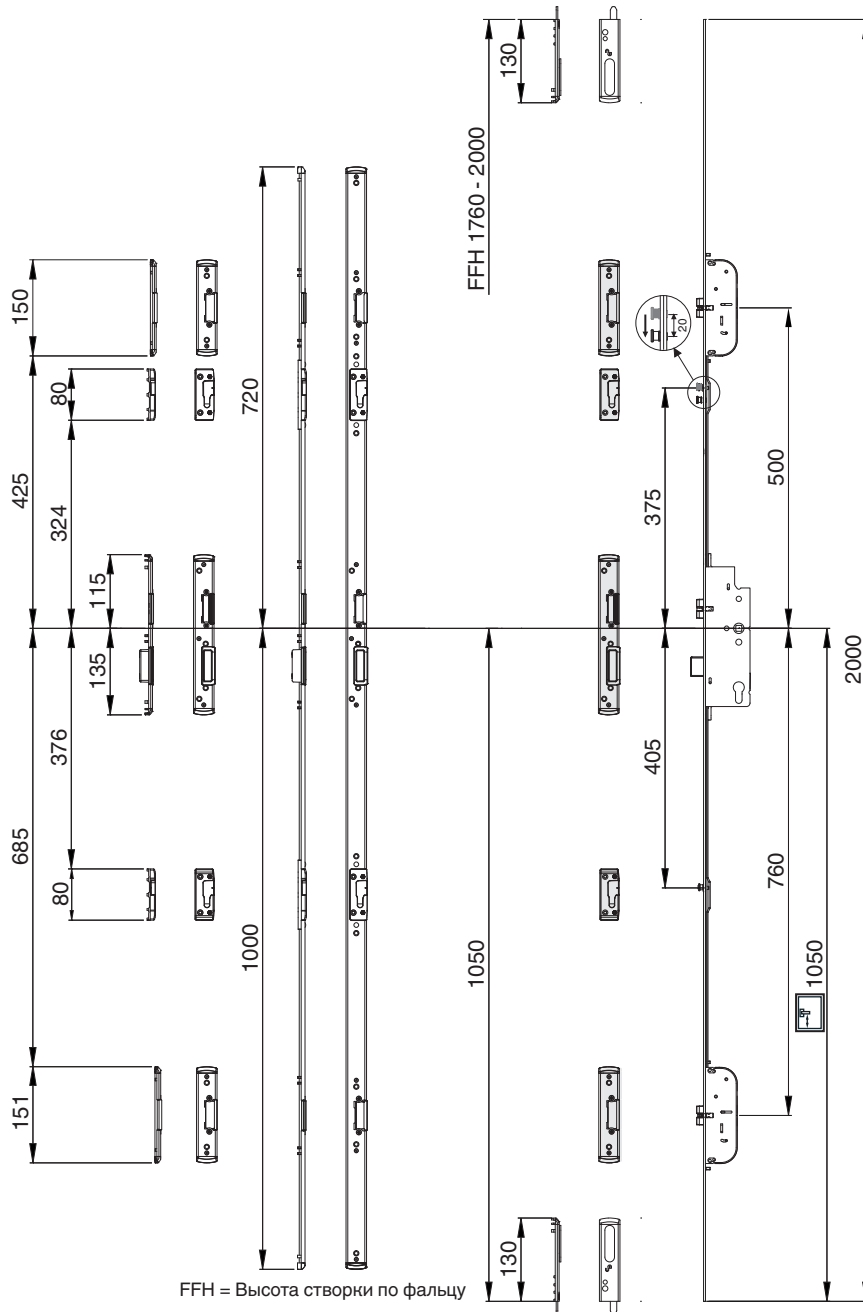

2 фалевые защёлки + 3 i.S. цапфы K+1030
1 и 2 - створчатые

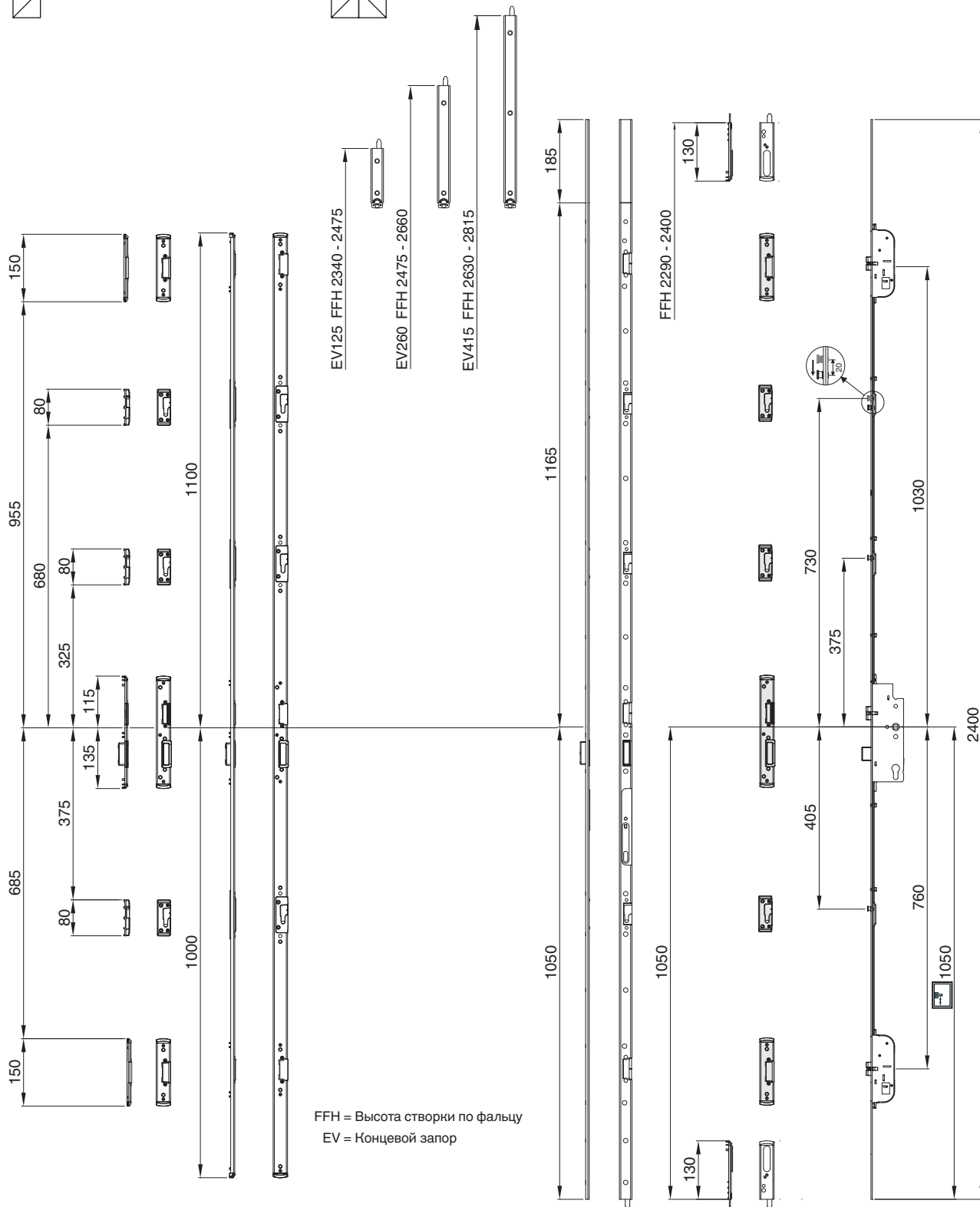

3.2 Дверной замок Z-TF i.S. PT

3.2.1 E92 Штульп F-16

235775

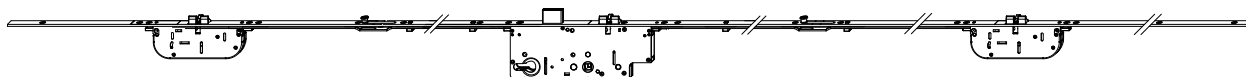

3.2.1.1 Дверной замок Z-TF PT с 2 фалевыми защёлками и 2 i.S. цапфами Штульп F-16



№

€

не удлин.

| 92 | 35 | 8 | 1.050 | 1.950 - 2.400 | 16 | 2.400 | 5 | 235770 | |
|----|----|----|-------|---------------|----|-------|---|--------|--|
| | | 10 | 1.050 | 1.950 - 2.400 | 16 | 2.400 | 5 | 235780 | |
| | 40 | 8 | 1.050 | 1.950 - 2.400 | 16 | 2.400 | 5 | 235771 | |
| | | 10 | 1.050 | 1.950 - 2.400 | 16 | 2.400 | 5 | 235781 | |
| | 45 | 8 | 1.050 | 1.950 - 2.400 | 16 | 2.400 | 5 | 235772 | |
| | | 10 | 1.050 | 1.950 - 2.400 | 16 | 2.400 | 5 | 235782 | |
| | 50 | 8 | 1.050 | 1.950 - 2.400 | 16 | 2.400 | 5 | 235773 | |
| | | 10 | 1.050 | 1.950 - 2.400 | 16 | 2.400 | 5 | 235783 | |
| | 55 | 8 | 1.050 | 1.950 - 2.400 | 16 | 2.400 | 5 | 235774 | |
| | | 10 | 1.050 | 1.950 - 2.400 | 16 | 2.400 | 5 | 235784 | |
| | 65 | 8 | 1.050 | 1.950 - 2.400 | 16 | 2.400 | 5 | 235775 | |
| | | 10 | 1.050 | 1.950 - 2.400 | 16 | 2.400 | 5 | 235785 | |
| | 70 | 8 | 1.050 | 1.950 - 2.400 | 16 | 2.400 | 5 | 235776 | |
| | | 10 | 1.050 | 1.950 - 2.400 | 16 | 2.400 | 5 | 235786 | |
| | 80 | 8 | 1.050 | 1.950 - 2.400 | 16 | 2.400 | 5 | 235777 | |
| | | 10 | 1.050 | 1.950 - 2.400 | 16 | 2.400 | 5 | 235787 | |

237854



3.2.1.2 Дверной замок Z-TF PT с 2 фалевыми защёлками и 2 i.S. цапфами Штульп F-16 K+500

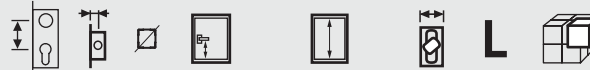

№

€







не удлин.

| 92 | 35 | 8 | 1.050 | 1.700 - 2.000 | 16 | 2.000 | 5 | 237850 | |
|----|----|----|-------|---------------|----|-------|---|--------|--|
| | | 10 | 1.050 | 1.700 - 2.000 | 16 | 2.000 | 5 | 237870 | |
| | 40 | 8 | 1.050 | 1.700 - 2.000 | 16 | 2.000 | 5 | 237851 | |
| | | 10 | 1.050 | 1.700 - 2.000 | 16 | 2.000 | 5 | 237871 | |
| | 45 | 8 | 1.050 | 1.700 - 2.000 | 16 | 2.000 | 5 | 237852 | |
| | | 10 | 1.050 | 1.700 - 2.000 | 16 | 2.000 | 5 | 237872 | |
| | 50 | 8 | 1.050 | 1.700 - 2.000 | 16 | 2.000 | 5 | 237853 | |
| | | 10 | 1.050 | 1.700 - 2.000 | 16 | 2.000 | 5 | 237873 | |
| | 55 | 8 | 1.050 | 1.700 - 2.000 | 16 | 2.000 | 5 | 237854 | |
| | | 10 | 1.050 | 1.700 - 2.000 | 16 | 2.000 | 5 | 237874 | |
| | 65 | 8 | 1.050 | 1.700 - 2.000 | 16 | 2.000 | 5 | 237855 | |
| | | 10 | 1.050 | 1.700 - 2.000 | 16 | 2.000 | 5 | 237875 | |
| | 70 | 8 | 1.050 | 1.700 - 2.000 | 16 | 2.000 | 5 | 237856 | |
| | | 10 | 1.050 | 1.700 - 2.000 | 16 | 2.000 | 5 | 237876 | |
| | 80 | 8 | 1.050 | 1.700 - 2.000 | 16 | 2.000 | 5 | 237857 | |
| | | 10 | 1.050 | 1.700 - 2.000 | 16 | 2.000 | 5 | 237877 | |

234774



3.2.1.3 Дверной замок Z-TF PT с 2 фалевыми защёлками и 3 i.S. цапфами Штульп F-16 K+1030





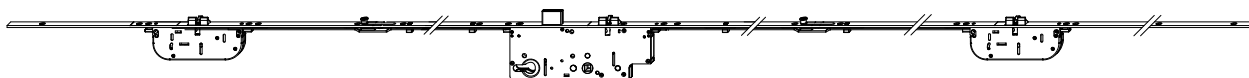

| |  |  |  |  |  | L |  | № | € |
|-----------|---|---|---|---|---|----------|---|----------|---------------|
| не удлин. | 92 | 35 | 8 | 1.050 | 2.250 - 2.400 | 16 | 2.400 | 5 | 234770 |
| | | | 10 | 1.050 | 2.250 - 2.400 | 16 | 2.400 | 5 | 234200 |
| | 40 | | 8 | 1.050 | 2.250 - 2.400 | 16 | 2.400 | 5 | 234771 |
| | | | 10 | 1.050 | 2.250 - 2.400 | 16 | 2.400 | 5 | 234201 |
| | 45 | | 8 | 1.050 | 2.250 - 2.400 | 16 | 2.400 | 5 | 234772 |
| | | | 10 | 1.050 | 2.250 - 2.400 | 16 | 2.400 | 5 | 234202 |
| | 50 | | 8 | 1.050 | 2.250 - 2.400 | 16 | 2.400 | 5 | 234773 |
| | | | 10 | 1.050 | 2.250 - 2.400 | 16 | 2.400 | 5 | 234203 |
| | 55 | | 8 | 1.050 | 2.250 - 2.400 | 16 | 2.400 | 5 | 234774 |
| | | | 10 | 1.050 | 2.250 - 2.400 | 16 | 2.400 | 5 | 234204 |
| | 65 | | 8 | 1.050 | 2.250 - 2.400 | 16 | 2.400 | 5 | 234775 |
| | | | 10 | 1.050 | 2.250 - 2.400 | 16 | 2.400 | 5 | 234205 |
| | 70 | | 8 | 1.050 | 2.250 - 2.400 | 16 | 2.400 | 5 | 234776 |
| | | | 10 | 1.050 | 2.250 - 2.400 | 16 | 2.400 | 5 | 234206 |
| | 80 | | 8 | 1.050 | 2.250 - 2.400 | 16 | 2.400 | 5 | 234777 |
| | | | 10 | 1.050 | 2.250 - 2.400 | 16 | 2.400 | 5 | 234207 |

3.2.2 E92 Штульп F-20

235340



3.2.2.1 Дверной замок Z-TF PT с 2 фалевыми защёлками и 2 i.S. цапфами Штульп F-20

| |  |  |  |  |  | L |  | № | € |
|-----------|---|---|---|---|---|----------|---|----------|---------------|
| не удлин. | 92 | 35 | 8 | 1.050 | 1.950 - 2.400 | 20 | 2.400 | 5 | 235340 |
| | | | 10 | 1.050 | 1.950 - 2.400 | 20 | 2.400 | 5 | 235350 |
| | 40 | | 8 | 1.050 | 1.950 - 2.400 | 20 | 2.400 | 5 | 235341 |
| | | | 10 | 1.050 | 1.950 - 2.400 | 20 | 2.400 | 5 | 235351 |
| | 45 | | 8 | 1.050 | 1.950 - 2.400 | 20 | 2.400 | 5 | 235342 |
| | | | 10 | 1.050 | 1.950 - 2.400 | 20 | 2.400 | 5 | 235352 |
| | 50 | | 8 | 1.050 | 1.950 - 2.400 | 20 | 2.400 | 5 | 235343 |
| | | | 10 | 1.050 | 1.950 - 2.400 | 20 | 2.400 | 5 | 235353 |
| | 55 | | 8 | 1.050 | 1.950 - 2.400 | 20 | 2.400 | 5 | 235344 |
| | | | 10 | 1.050 | 1.950 - 2.400 | 20 | 2.400 | 5 | 235354 |
| | 65 | | 8 | 1.050 | 1.950 - 2.400 | 20 | 2.400 | 5 | 235345 |
| | | | 10 | 1.050 | 1.950 - 2.400 | 20 | 2.400 | 5 | 235355 |
| | 70 | | 8 | 1.050 | 1.950 - 2.400 | 20 | 2.400 | 5 | 235346 |
| | | | 10 | 1.050 | 1.950 - 2.400 | 20 | 2.400 | 5 | 235356 |
| | 80 | | 8 | 1.050 | 1.950 - 2.400 | 20 | 2.400 | 5 | 235347 |
| | | | 10 | 1.050 | 1.950 - 2.400 | 20 | 2.400 | 5 | 235357 |

238034



3.2.2.2 Дверной замок Z-TF PT с 2 фалевыми защёлками и 2 i.S. цапфами Штульп F-20 K+500



№

€

не удлин.

| 92 | 35 | 8 | 1.050 | 1.700 - 2.000 | 20 | 2.000 | 5 | № | € |
|----|----|----|-------|---------------|----|-------|---|--------|---|
| | | 10 | 1.050 | 1.700 - 2.000 | 20 | 2.000 | 5 | 238030 | |
| | 40 | 8 | 1.050 | 1.700 - 2.000 | 20 | 2.000 | 5 | 238031 | |
| | | 10 | 1.050 | 1.700 - 2.000 | 20 | 2.000 | 5 | 238051 | |
| | 45 | 8 | 1.050 | 1.700 - 2.000 | 20 | 2.000 | 5 | 238032 | |
| | | 10 | 1.050 | 1.700 - 2.000 | 20 | 2.000 | 5 | 238052 | |
| | 50 | 8 | 1.050 | 1.700 - 2.000 | 20 | 2.000 | 5 | 238033 | |
| | | 10 | 1.050 | 1.700 - 2.000 | 20 | 2.000 | 5 | 238053 | |
| | 55 | 8 | 1.050 | 1.700 - 2.000 | 20 | 2.000 | 5 | 238034 | |
| | | 10 | 1.050 | 1.700 - 2.000 | 20 | 2.000 | 5 | 238054 | |
| | 65 | 8 | 1.050 | 1.700 - 2.000 | 20 | 2.000 | 5 | 238035 | |
| | | 10 | 1.050 | 1.700 - 2.000 | 20 | 2.000 | 5 | 238055 | |
| | 70 | 8 | 1.050 | 1.700 - 2.000 | 20 | 2.000 | 5 | 238036 | |
| | | 10 | 1.050 | 1.700 - 2.000 | 20 | 2.000 | 5 | 238056 | |
| | 80 | 8 | 1.050 | 1.700 - 2.000 | 20 | 2.000 | 5 | 238037 | |
| | | 10 | 1.050 | 1.700 - 2.000 | 20 | 2.000 | 5 | 238057 | |

234794



3.2.2.3 Дверной замок Z-TF PT с 2 фалевыми защёлками и 3 i.S. цапфами Штульп F-20 K+1030



№

€

не удлин.

| 92 | 35 | 8 | 1.050 | 2.250 - 2.400 | 20 | 2.400 | 5 | № | € |
|----|----|----|-------|---------------|----|-------|---|--------|---|
| | | 10 | 1.050 | 2.250 - 2.400 | 20 | 2.400 | 5 | 234790 | |
| | 40 | 8 | 1.050 | 2.250 - 2.400 | 20 | 2.400 | 5 | 234791 | |
| | | 10 | 1.050 | 2.250 - 2.400 | 20 | 2.400 | 5 | 234231 | |
| | 45 | 8 | 1.050 | 2.250 - 2.400 | 20 | 2.400 | 5 | 234792 | |
| | | 10 | 1.050 | 2.250 - 2.400 | 20 | 2.400 | 5 | 234232 | |
| | 50 | 8 | 1.050 | 2.250 - 2.400 | 20 | 2.400 | 5 | 234793 | |
| | | 10 | 1.050 | 2.250 - 2.400 | 20 | 2.400 | 5 | 234233 | |
| | 55 | 8 | 1.050 | 2.250 - 2.400 | 20 | 2.400 | 5 | 234794 | |
| | | 10 | 1.050 | 2.250 - 2.400 | 20 | 2.400 | 5 | 234234 | |
| | 65 | 8 | 1.050 | 2.250 - 2.400 | 20 | 2.400 | 5 | 234795 | |
| | | 10 | 1.050 | 2.250 - 2.400 | 20 | 2.400 | 5 | 234235 | |
| | 70 | 8 | 1.050 | 2.250 - 2.400 | 20 | 2.400 | 5 | 234796 | |
| | | 10 | 1.050 | 2.250 - 2.400 | 20 | 2.400 | 5 | 234236 | |
| | 80 | 8 | 1.050 | 2.250 - 2.400 | 20 | 2.400 | 5 | 234797 | |
| | | 10 | 1.050 | 2.250 - 2.400 | 20 | 2.400 | 5 | 234237 | |

3.2.3 E92 Штульп F-24

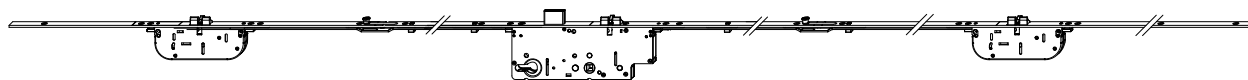

235370

3.2.3.1 Дверной замок Z-TF PT с 2 фалевыми защёлками и 2 i.S. цапфами Штульп F-24

| не удлин. | 92 | 35 | 8 | 1.050 | 1.950 - 2.400 | 24 | 2.400 | 5 | № | € |
|-----------|----|----|----|-------|---------------|----|-------|---|--------|---|
| | | | | | | | | | | |
| | | | 10 | 1.050 | 1.950 - 2.400 | 24 | 2.400 | 5 | 235370 | |
| | | | 10 | 1.050 | 1.950 - 2.400 | 24 | 2.400 | 5 | 235380 | |
| | | 40 | 8 | 1.050 | 1.950 - 2.400 | 24 | 2.400 | 5 | 235371 | |
| | | | 10 | 1.050 | 1.950 - 2.400 | 24 | 2.400 | 5 | 235381 | |
| | | | 8 | 1.050 | 1.950 - 2.400 | 24 | 2.400 | 5 | 235372 | |
| | | | 10 | 1.050 | 1.950 - 2.400 | 24 | 2.400 | 5 | 235382 | |
| | | | 8 | 1.050 | 1.950 - 2.400 | 24 | 2.400 | 5 | 235373 | |
| | | | 10 | 1.050 | 1.950 - 2.400 | 24 | 2.400 | 5 | 235383 | |
| | | | 8 | 1.050 | 1.950 - 2.400 | 24 | 2.400 | 5 | 235374 | |
| | | | 10 | 1.050 | 1.950 - 2.400 | 24 | 2.400 | 5 | 235384 | |
| | | | 8 | 1.050 | 1.950 - 2.400 | 24 | 2.400 | 5 | 235375 | |
| | | | 10 | 1.050 | 1.950 - 2.400 | 24 | 2.400 | 5 | 235385 | |
| | | | 8 | 1.050 | 1.950 - 2.400 | 24 | 2.400 | 5 | 235376 | |
| | | | 10 | 1.050 | 1.950 - 2.400 | 24 | 2.400 | 5 | 235386 | |
| | | | 8 | 1.050 | 1.950 - 2.400 | 24 | 2.400 | 5 | 235377 | |
| | | | 10 | 1.050 | 1.950 - 2.400 | 24 | 2.400 | 5 | 235387 | |

3.2.4 E92 Штульп F-24/16 Hutstulp *

* Детальную информацию по Hutstulp Вы найдёте в разделе 10 "Технические данные и информация"

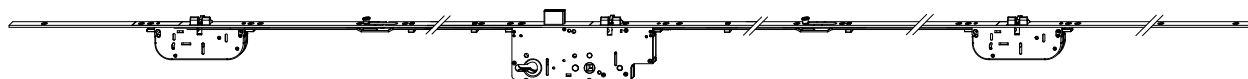

237650

3.2.4.1 Дверной замок Z-TF PT с 2 фалевыми защёлками и 2 i.S. цапфами Штульп F-24/16

| не удлин. | 92 | 35 | 8 | 1.050 | 1.950 - 2.400 | 24 | 2.400 | 5 | № | € |
|-----------|----|----|----|-------|---------------|----|-------|---|--------|---|
| | | | | | | | | | | |
| | | | 10 | 1.050 | 1.950 - 2.400 | 24 | 2.400 | 5 | 237650 | |
| | | | 10 | 1.050 | 1.950 - 2.400 | 24 | 2.400 | 5 | 237660 | |
| | | 40 | 8 | 1.050 | 1.950 - 2.400 | 24 | 2.400 | 5 | 237651 | |
| | | | 10 | 1.050 | 1.950 - 2.400 | 24 | 2.400 | 5 | 237661 | |
| | | | 8 | 1.050 | 1.950 - 2.400 | 24 | 2.400 | 5 | 237652 | |
| | | | 10 | 1.050 | 1.950 - 2.400 | 24 | 2.400 | 5 | 237662 | |
| | | | 8 | 1.050 | 1.950 - 2.400 | 24 | 2.400 | 5 | 237653 | |
| | | | 10 | 1.050 | 1.950 - 2.400 | 24 | 2.400 | 5 | 237663 | |
| | | | 8 | 1.050 | 1.950 - 2.400 | 24 | 2.400 | 5 | 237654 | |
| | | | 10 | 1.050 | 1.950 - 2.400 | 24 | 2.400 | 5 | 237664 | |
| | | | 8 | 1.050 | 1.950 - 2.400 | 24 | 2.400 | 5 | 237655 | |
| | | | 10 | 1.050 | 1.950 - 2.400 | 24 | 2.400 | 5 | 237665 | |
| | | | 8 | 1.050 | 1.950 - 2.400 | 24 | 2.400 | 5 | 237656 | |
| | | | 10 | 1.050 | 1.950 - 2.400 | 24 | 2.400 | 5 | 237666 | |
| | | | 8 | 1.050 | 1.950 - 2.400 | 24 | 2.400 | 5 | 237657 | |
| | | | 10 | 1.050 | 1.950 - 2.400 | 24 | 2.400 | 5 | 237667 | |

238214

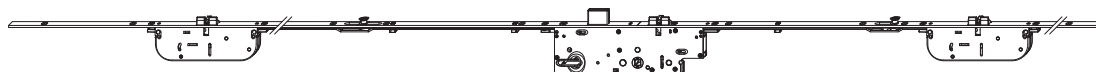

3.2.4.2 Дверной замок Z-TF PT с 2 фалевыми защёлками и 2 i.S. цапфами Штульп F-24/16 K+500



№

€

не удлин.

| 92 | 35 | 8 | 1.050 | 1.700 - 2.000 | 24 | 2.000 | 5 | № | € |
|----|----|----|-------|---------------|----|-------|---|--------|---|
| | | 10 | 1.050 | 1.700 - 2.000 | 24 | 2.000 | 5 | 238210 | |
| | 40 | 8 | 1.050 | 1.700 - 2.000 | 24 | 2.000 | 5 | 238211 | |
| | | 10 | 1.050 | 1.700 - 2.000 | 24 | 2.000 | 5 | 238231 | |
| | 45 | 8 | 1.050 | 1.700 - 2.000 | 24 | 2.000 | 5 | 238212 | |
| | | 10 | 1.050 | 1.700 - 2.000 | 24 | 2.000 | 5 | 238232 | |
| | 50 | 8 | 1.050 | 1.700 - 2.000 | 24 | 2.000 | 5 | 238213 | |
| | | 10 | 1.050 | 1.700 - 2.000 | 24 | 2.000 | 5 | 238233 | |
| | 55 | 8 | 1.050 | 1.700 - 2.000 | 24 | 2.000 | 5 | 238214 | |
| | | 10 | 1.050 | 1.700 - 2.000 | 24 | 2.000 | 5 | 238234 | |
| | 65 | 8 | 1.050 | 1.700 - 2.000 | 24 | 2.000 | 5 | 238215 | |
| | | 10 | 1.050 | 1.700 - 2.000 | 24 | 2.000 | 5 | 238235 | |
| | 70 | 8 | 1.050 | 1.700 - 2.000 | 24 | 2.000 | 5 | 238216 | |
| | | 10 | 1.050 | 1.700 - 2.000 | 24 | 2.000 | 5 | 238236 | |
| | 80 | 8 | 1.050 | 1.700 - 2.000 | 24 | 2.000 | 5 | 238217 | |
| | | 10 | 1.050 | 1.700 - 2.000 | 24 | 2.000 | 5 | 238237 | |

237684

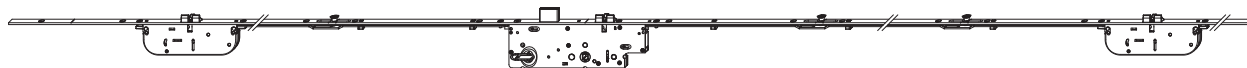

3.2.4.3 Дверной замок Z-TF PT с 2 фалевыми защёлками и 3 i.S. цапфами Штульп F-24/16 K+1030



№

€

не удлин.

| 92 | 35 | 8 | 1.050 | 2.250 - 2.400 | 24 | 2.400 | 5 | № | € |
|----|----|----|-------|---------------|----|-------|---|--------|---|
| | | 10 | 1.050 | 2.250 - 2.400 | 24 | 2.400 | 5 | 237680 | |
| | 40 | 8 | 1.050 | 2.250 - 2.400 | 24 | 2.400 | 5 | 237681 | |
| | | 10 | 1.050 | 2.250 - 2.400 | 24 | 2.400 | 5 | 237691 | |
| | 45 | 8 | 1.050 | 2.250 - 2.400 | 24 | 2.400 | 5 | 237682 | |
| | | 10 | 1.050 | 2.250 - 2.400 | 24 | 2.400 | 5 | 237692 | |
| | 50 | 8 | 1.050 | 2.250 - 2.400 | 24 | 2.400 | 5 | 237683 | |
| | | 10 | 1.050 | 2.250 - 2.400 | 24 | 2.400 | 5 | 237693 | |
| | 55 | 8 | 1.050 | 2.250 - 2.400 | 24 | 2.400 | 5 | 237684 | |
| | | 10 | 1.050 | 2.250 - 2.400 | 24 | 2.400 | 5 | 237694 | |
| | 65 | 8 | 1.050 | 2.250 - 2.400 | 24 | 2.400 | 5 | 237685 | |
| | | 10 | 1.050 | 2.250 - 2.400 | 24 | 2.400 | 5 | 237695 | |
| | 70 | 8 | 1.050 | 2.250 - 2.400 | 24 | 2.400 | 5 | 237686 | |
| | | 10 | 1.050 | 2.250 - 2.400 | 24 | 2.400 | 5 | 237696 | |
| | 80 | 8 | 1.050 | 2.250 - 2.400 | 24 | 2.400 | 5 | 237687 | |
| | | 10 | 1.050 | 2.250 - 2.400 | 24 | 2.400 | 5 | 237697 | |

3.3 Монтажная схема замка Z-TF PT с i.S. цапфами WK2

2 фалевые защёлки + 4 i.S. цапфы
с концевым запором 300 мм*

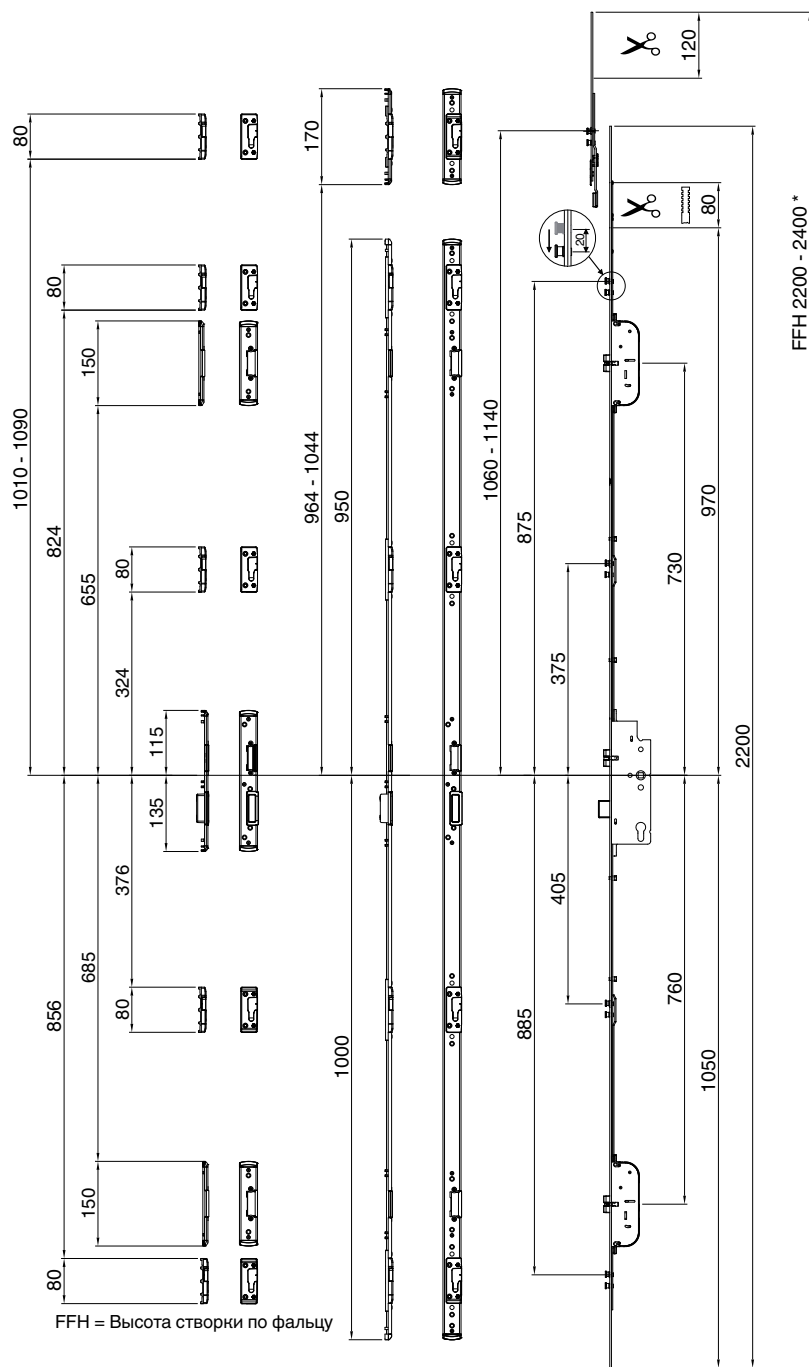

2 фалевые защёлки + 4 i.S. цапфы
с концевым запором 500 мм*

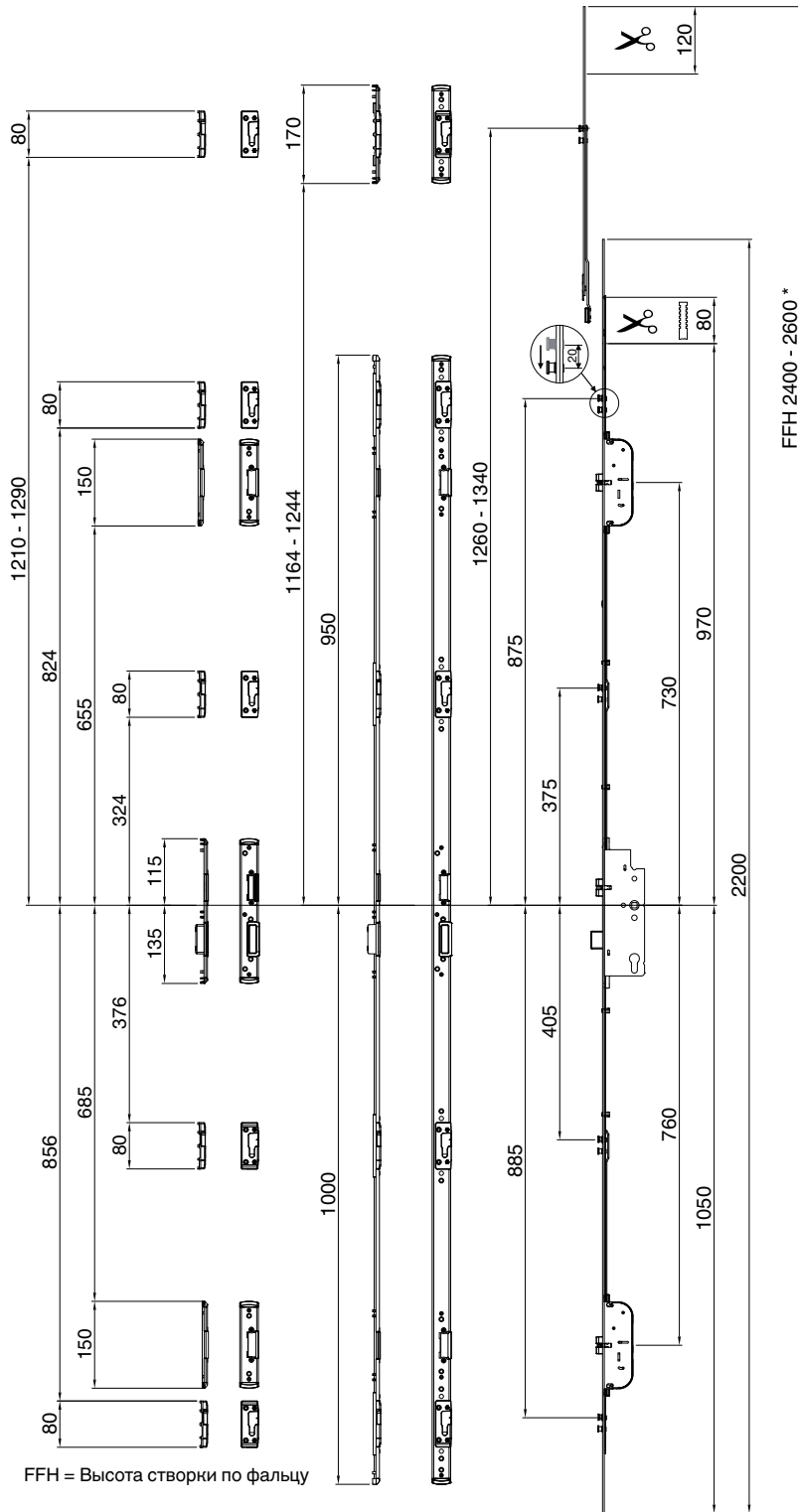

2 фалевые защёлки + 4 i.S. цапфы K+500
с концевым запором 300 мм*

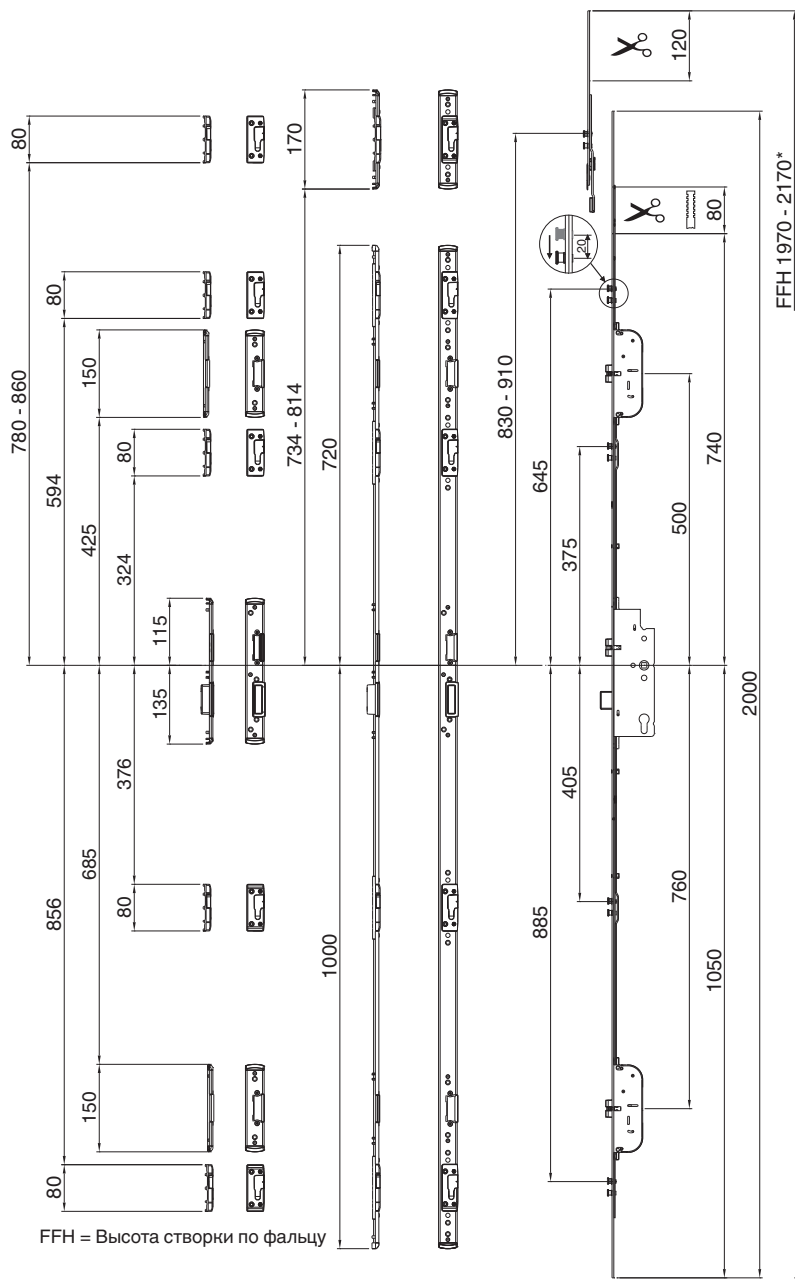

2 фалевые защёлки + 4 i.S. цапфы K+500
с концевым запором 500 мм*

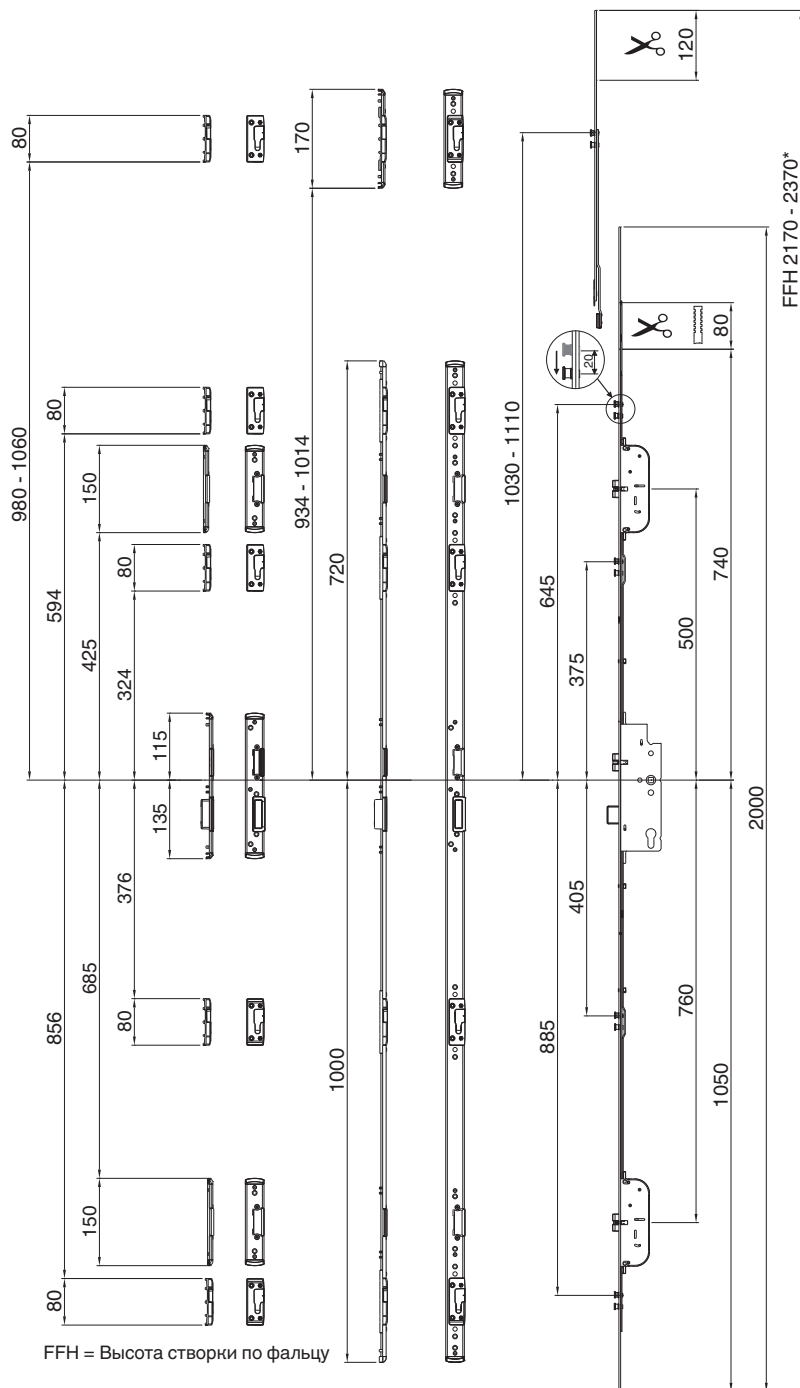

3.4 Дверной замок Z-TF i.S. PT с возможностью WK2

3.4.1 E92 Штульп F-16

237734

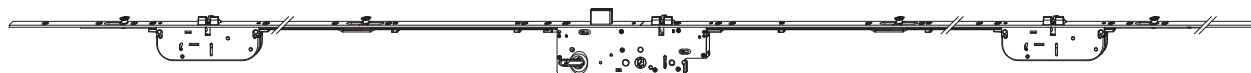

3.4.1.1 Дверной замок Z-TF PT с 2 фалевыми защёлками и 4 i.S. цапфами Штульп F-16

| удлин. | 92 | 35 | 8 | 1.050 | 2.000 - 2.200 | 16 | 2.200 | 5 | № | € |
|--------|----|----|---|-------|---------------|----|-------|---|--------|---|
| | | | | | | | | | | |
| | | | | | | | | | 237730 | |
| | | | | | | | | | 237750 | |
| | | 40 | 8 | 1.050 | 2.000 - 2.200 | 16 | 2.200 | 5 | 237731 | |
| | | | | | | | | | 237751 | |
| | | 45 | 8 | 1.050 | 2.000 - 2.200 | 16 | 2.200 | 5 | 237732 | |
| | | | | | | | | | 237752 | |
| | | 50 | 8 | 1.050 | 2.000 - 2.200 | 16 | 2.200 | 5 | 237733 | |
| | | | | | | | | | 237753 | |
| | | 55 | 8 | 1.050 | 2.000 - 2.200 | 16 | 2.200 | 5 | 237734 | |
| | | | | | | | | | 237754 | |
| | | 65 | 8 | 1.050 | 2.000 - 2.200 | 16 | 2.200 | 5 | 237735 | |
| | | | | | | | | | 237755 | |
| | | 70 | 8 | 1.050 | 2.000 - 2.200 | 16 | 2.200 | 5 | 237736 | |
| | | | | | | | | | 237756 | |
| | | 80 | 8 | 1.050 | 2.000 - 2.200 | 16 | 2.200 | 5 | 237737 | |
| | | | | | | | | | 237757 | |

237794



3.4.1.2 Дверной замок Z-TF PT с 2 фалевыми защёлками и 4 i.S. цапфами Штульп F-16 K+500

| удлин. | 92 | 35 | 8 | 1.050 | 1.750 - 2.000 | 16 | 2.000 | 5 | № | € |
|--------|----|----|---|-------|---------------|----|-------|---|--------|---|
| | | | | | | | | | | |
| | | | | | | | | | 237790 | |
| | | | | | | | | | 237810 | |
| | | 40 | 8 | 1.050 | 1.750 - 2.000 | 16 | 2.000 | 5 | 237791 | |
| | | | | | | | | | 237811 | |
| | | 45 | 8 | 1.050 | 1.750 - 2.000 | 16 | 2.000 | 5 | 237792 | |
| | | | | | | | | | 237812 | |
| | | 50 | 8 | 1.050 | 1.750 - 2.000 | 16 | 2.000 | 5 | 237793 | |
| | | | | | | | | | 237813 | |
| | | 55 | 8 | 1.050 | 1.750 - 2.000 | 16 | 2.000 | 5 | 237794 | |
| | | | | | | | | | 237814 | |
| | | 65 | 8 | 1.050 | 1.750 - 2.000 | 16 | 2.000 | 5 | 237795 | |
| | | | | | | | | | 237815 | |
| | | 70 | 8 | 1.050 | 1.750 - 2.000 | 16 | 2.000 | 5 | 237796 | |
| | | | | | | | | | 237816 | |
| | | 80 | 8 | 1.050 | 1.750 - 2.000 | 16 | 2.000 | 5 | 237797 | |
| | | | | | | | | | 237817 | |

3.4.2 E92 Штульп F-20

237914

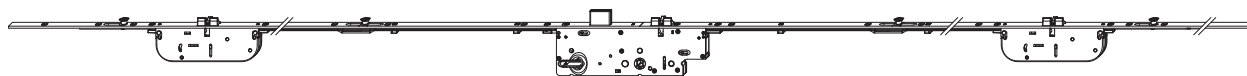

3.4.2.1 Дверной замок Z-TF PT с 2 фалевыми защёлками и 4 i.S. цапфами Штульп F-20

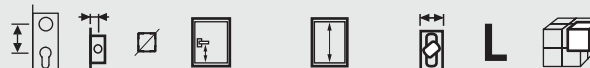

| удлин. | 92 | 35 | 8 | 1.050 | 2.000 - 2.200 | 20 | 2.200 | 5 | № | € |
|--------|----|----|-------|---------------|---------------|-------|-------|--------|--------|---|
| | | | 10 | 1.050 | 2.000 - 2.200 | 20 | 2.200 | 5 | 237910 | |
| | 40 | 8 | 1.050 | 2.000 - 2.200 | 20 | 2.200 | 5 | 237911 | | |
| | | 10 | 1.050 | 2.000 - 2.200 | 20 | 2.200 | 5 | 237931 | | |
| | 45 | 8 | 1.050 | 2.000 - 2.200 | 20 | 2.200 | 5 | 237912 | | |
| | | 10 | 1.050 | 2.000 - 2.200 | 20 | 2.200 | 5 | 237932 | | |
| | 50 | 8 | 1.050 | 2.000 - 2.200 | 20 | 2.200 | 5 | 237913 | | |
| | | 10 | 1.050 | 2.000 - 2.200 | 20 | 2.200 | 5 | 237933 | | |
| | 55 | 8 | 1.050 | 2.000 - 2.200 | 20 | 2.200 | 5 | 237914 | | |
| | | 10 | 1.050 | 2.000 - 2.200 | 20 | 2.200 | 5 | 237934 | | |
| | 65 | 8 | 1.050 | 2.000 - 2.200 | 20 | 2.200 | 5 | 237915 | | |
| | | 10 | 1.050 | 2.000 - 2.200 | 20 | 2.200 | 5 | 237935 | | |
| | 70 | 8 | 1.050 | 2.000 - 2.200 | 20 | 2.200 | 5 | 237916 | | |
| | | 10 | 1.050 | 2.000 - 2.200 | 20 | 2.200 | 5 | 237936 | | |
| | 80 | 8 | 1.050 | 2.000 - 2.200 | 20 | 2.200 | 5 | 237917 | | |
| | | 10 | 1.050 | 2.000 - 2.200 | 20 | 2.200 | 5 | 237937 | | |

237974



3.4.2.2 Дверной замок Z-TF PT с 2 фалевыми защёлками и 4 i.S. цапфами Штульп F-20 K+500



| удлин. | 92 | 35 | 8 | 1.050 | 1.750 - 2.000 | 20 | 2.000 | 5 | № | € |
|--------|----|----|-------|---------------|---------------|-------|-------|--------|--------|---|
| | | | 10 | 1.050 | 1.750 - 2.000 | 20 | 2.000 | 5 | 237970 | |
| | 40 | 8 | 1.050 | 1.750 - 2.000 | 20 | 2.000 | 5 | 237971 | | |
| | | 10 | 1.050 | 1.750 - 2.000 | 20 | 2.000 | 5 | 237991 | | |
| | 45 | 8 | 1.050 | 1.750 - 2.000 | 20 | 2.000 | 5 | 237972 | | |
| | | 10 | 1.050 | 1.750 - 2.000 | 20 | 2.000 | 5 | 237992 | | |
| | 50 | 8 | 1.050 | 1.750 - 2.000 | 20 | 2.000 | 5 | 237973 | | |
| | | 10 | 1.050 | 1.750 - 2.000 | 20 | 2.000 | 5 | 237993 | | |
| | 55 | 8 | 1.050 | 1.750 - 2.000 | 20 | 2.000 | 5 | 237974 | | |
| | | 10 | 1.050 | 1.750 - 2.000 | 20 | 2.000 | 5 | 237994 | | |
| | 65 | 8 | 1.050 | 1.750 - 2.000 | 20 | 2.000 | 5 | 237975 | | |
| | | 10 | 1.050 | 1.750 - 2.000 | 20 | 2.000 | 5 | 237995 | | |
| | 70 | 8 | 1.050 | 1.750 - 2.000 | 20 | 2.000 | 5 | 237976 | | |
| | | 10 | 1.050 | 1.750 - 2.000 | 20 | 2.000 | 5 | 237996 | | |
| | 80 | 8 | 1.050 | 1.750 - 2.000 | 20 | 2.000 | 5 | 237977 | | |
| | | 10 | 1.050 | 1.750 - 2.000 | 20 | 2.000 | 5 | 237997 | | |

3.4.3 E92 Штульп F-24

238274

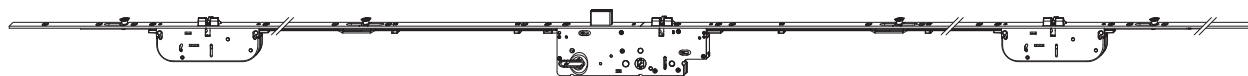

3.4.3.1 Дверной замок Z-TF PT с 2 фалевыми защёлками и 4 i.S. цапфами Штульп F-24

| удлин. | 92 | 35 | 8 | | 1.050 | | 2.000 - 2.200 | | 24 | 2.200 | 5 | № | € |
|--------|----|----|----|--|-------|--|---------------|--|----|-------|---|--------|---|
| | | | 10 | | 1.050 | | 2.000 - 2.200 | | | | | | |
| | | 40 | 8 | | 1.050 | | 2.000 - 2.200 | | 24 | 2.200 | 5 | 238270 | |
| | | | 10 | | 1.050 | | 2.000 - 2.200 | | 24 | 2.200 | 5 | 238290 | |
| | | 40 | 8 | | 1.050 | | 2.000 - 2.200 | | 24 | 2.200 | 5 | 238271 | |
| | | | 10 | | 1.050 | | 2.000 - 2.200 | | 24 | 2.200 | 5 | 238291 | |
| | | 45 | 8 | | 1.050 | | 2.000 - 2.200 | | 24 | 2.200 | 5 | 238272 | |
| | | | 10 | | 1.050 | | 2.000 - 2.200 | | 24 | 2.200 | 5 | 238292 | |
| | | 50 | 8 | | 1.050 | | 2.000 - 2.200 | | 24 | 2.200 | 5 | 238273 | |
| | | | 10 | | 1.050 | | 2.000 - 2.200 | | 24 | 2.200 | 5 | 238293 | |
| | | 55 | 8 | | 1.050 | | 2.000 - 2.200 | | 24 | 2.200 | 5 | 238274 | |
| | | | 10 | | 1.050 | | 2.000 - 2.200 | | 24 | 2.200 | 5 | 238294 | |
| | | 65 | 8 | | 1.050 | | 2.000 - 2.200 | | 24 | 2.200 | 5 | 238275 | |
| | | | 10 | | 1.050 | | 2.000 - 2.200 | | 24 | 2.200 | 5 | 238295 | |
| | | 70 | 8 | | 1.050 | | 2.000 - 2.200 | | 24 | 2.200 | 5 | 238276 | |
| | | | 10 | | 1.050 | | 2.000 - 2.200 | | 24 | 2.200 | 5 | 238296 | |
| | | 80 | 8 | | 1.050 | | 2.000 - 2.200 | | 24 | 2.200 | 5 | 238277 | |
| | | | 10 | | 1.050 | | 2.000 - 2.200 | | 24 | 2.200 | 5 | 238297 | |

3.4.4 E92 Штульп F-24/16 Hutstulp *

* Детальную информацию по Hutstulp Вы найдёте в разделе 10 "Технические данные и информация"

238094

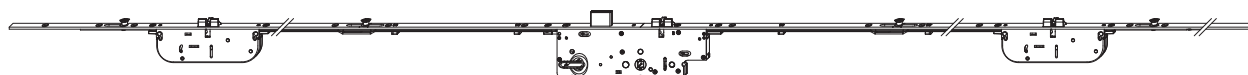

3.4.4.1 Дверной замок Z-TF PT с 2 фалевыми защёлками и 4 i.S. цапфами Штульп F-24/16

| удлин. | 92 | 35 | 8 | | 1.050 | | 2.000 - 2.200 | | 24 | 2.200 | 5 | № | € |
|--------|----|----|----|--|-------|--|---------------|--|----|-------|---|--------|---|
| | | | 10 | | 1.050 | | 2.000 - 2.200 | | | | | | |
| | | 40 | 8 | | 1.050 | | 2.000 - 2.200 | | 24 | 2.200 | 5 | 238090 | |
| | | | 10 | | 1.050 | | 2.000 - 2.200 | | 24 | 2.200 | 5 | 238110 | |
| | | 40 | 8 | | 1.050 | | 2.000 - 2.200 | | 24 | 2.200 | 5 | 238091 | |
| | | | 10 | | 1.050 | | 2.000 - 2.200 | | 24 | 2.200 | 5 | 238111 | |
| | | 45 | 8 | | 1.050 | | 2.000 - 2.200 | | 24 | 2.200 | 5 | 238092 | |
| | | | 10 | | 1.050 | | 2.000 - 2.200 | | 24 | 2.200 | 5 | 238112 | |
| | | 50 | 8 | | 1.050 | | 2.000 - 2.200 | | 24 | 2.200 | 5 | 238093 | |
| | | | 10 | | 1.050 | | 2.000 - 2.200 | | 24 | 2.200 | 5 | 238113 | |
| | | 55 | 8 | | 1.050 | | 2.000 - 2.200 | | 24 | 2.200 | 5 | 238094 | |
| | | | 10 | | 1.050 | | 2.000 - 2.200 | | 24 | 2.200 | 5 | 238114 | |
| | | 65 | 8 | | 1.050 | | 2.000 - 2.200 | | 24 | 2.200 | 5 | 238095 | |
| | | | 10 | | 1.050 | | 2.000 - 2.200 | | 24 | 2.200 | 5 | 238115 | |
| | | 70 | 8 | | 1.050 | | 2.000 - 2.200 | | 24 | 2.200 | 5 | 238096 | |
| | | | 10 | | 1.050 | | 2.000 - 2.200 | | 24 | 2.200 | 5 | 238116 | |
| | | 80 | 8 | | 1.050 | | 2.000 - 2.200 | | 24 | 2.200 | 5 | 238097 | |
| | | | 10 | | 1.050 | | 2.000 - 2.200 | | 24 | 2.200 | 5 | 238117 | |

238154



3.4.4.2 Дверной замок Z-TF PT с 2 фалевыми защёлками и 4 i.S. цапфами Штульп F-24/16 K+500



| удлин. | 92 | 35 | 8 | 1.050 | 1.750 - 2.000 | 24 | 2.000 | 5 | № | € |
|--------|----|----|----|-------|---------------|----|-------|---|--------|---|
| | | | 10 | 1.050 | 1.750 - 2.000 | 24 | 2.000 | 5 | 238170 | |
| | 40 | | 8 | 1.050 | 1.750 - 2.000 | 24 | 2.000 | 5 | 238151 | |
| | | | 10 | 1.050 | 1.750 - 2.000 | 24 | 2.000 | 5 | 238171 | |
| | 45 | | 8 | 1.050 | 1.750 - 2.000 | 24 | 2.200 | 5 | 238152 | |
| | | | 10 | 1.050 | 1.750 - 2.000 | 24 | 2.000 | 5 | 238172 | |
| | 50 | | 8 | 1.050 | 1.750 - 2.000 | 24 | 2.000 | 5 | 238153 | |
| | | | 10 | 1.050 | 1.750 - 2.000 | 24 | 2.000 | 5 | 238173 | |
| | 55 | | 8 | 1.050 | 1.750 - 2.000 | 24 | 2.000 | 5 | 238154 | |
| | | | 10 | 1.050 | 1.750 - 2.000 | 24 | 2.000 | 5 | 238174 | |
| | 65 | | 8 | 1.050 | 1.750 - 2.000 | 24 | 2.000 | 5 | 238155 | |
| | | | 10 | 1.050 | 1.750 - 2.000 | 24 | 2.000 | 5 | 238175 | |
| | 70 | | 8 | 1.050 | 1.750 - 2.000 | 24 | 2.000 | 5 | 238156 | |
| | | | 10 | 1.050 | 1.750 - 2.000 | 24 | 2.000 | 5 | 238176 | |
| | 80 | | 8 | 1.050 | 1.750 - 2.000 | 24 | 2.000 | 5 | 238157 | |
| | | | 10 | 1.050 | 1.750 - 2.000 | 24 | 2.000 | 5 | 238177 | |

101555



3.4.4.3 Сменная фалевая защёлка для замка Z-TS PT-M



№

€

| | | | |
|-------|----|--------|--|
| DM 35 | 10 | 101555 | |
| 40 | 10 | 101556 | |
| 45 | 10 | 101553 | |
| 50 | 10 | 101557 | |
| 55 | 10 | 101477 | |
| 65 | 10 | 101558 | |
| 70 | 10 | 101559 | |
| 80 | 10 | 101560 | |

102293



3.4.4.4 Сменная фалевая защёлка для замка Z-TF PT-M



№

€

Сменная многоф. фалевая защёлка для Z-TF с рифлен. шайбой

10

102293

362906



3.4.4.5 Пластиковый балансир



№

€

| | | | |
|------------------------------------|-----|--------|--|
| Клипса фалевой защёлки | 50 | 43586 | |
| Клипса для съёмной фалевой защёлки | 100 | 362906 | |

3.5 Монтажная схема замка Z-TF PT 2 фалевые защёлки - штыри

2 фалевые защёлки - штыри
1 и 2 створчатые

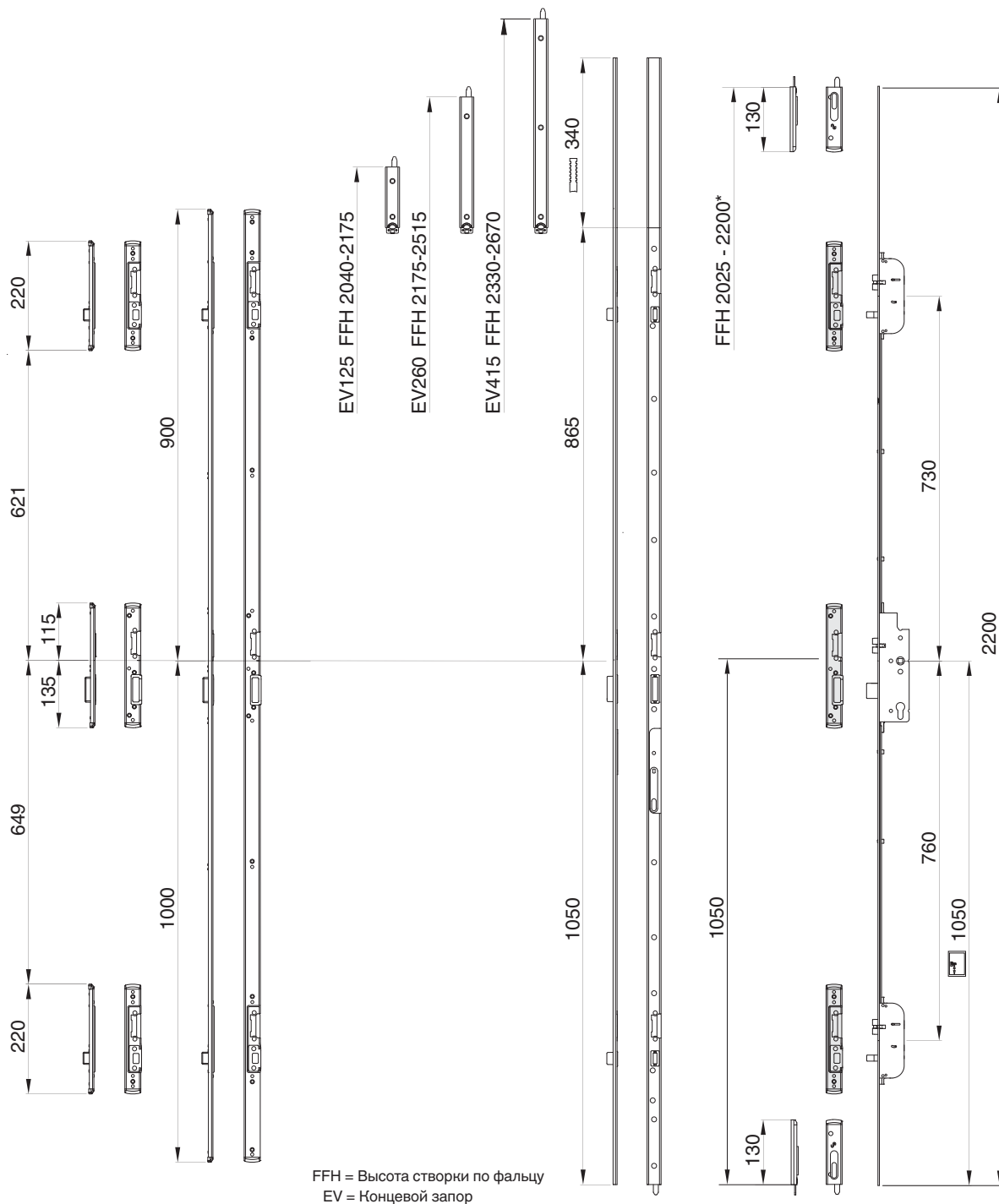

*Высота створки по фальцу при использовании шингалета - 2300 мм

2 фалевые защёлки - штыри К+605
1 и 2 створчатые

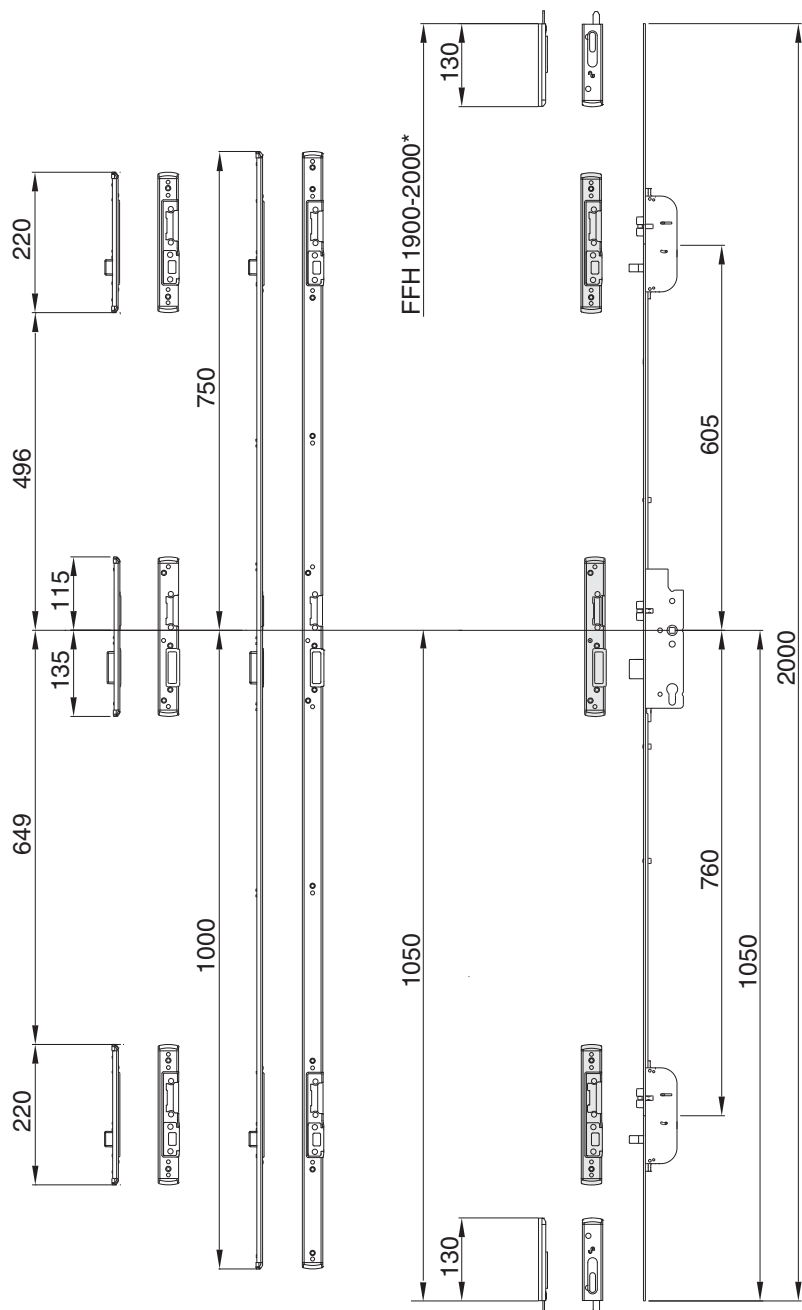

FFH = Высота створки по фальцу

*Высота створки по фальцу при использовании шпингалета - 2100 мм

2 фалевые защёлки - штыри К 980

1 и 2 - створчатые

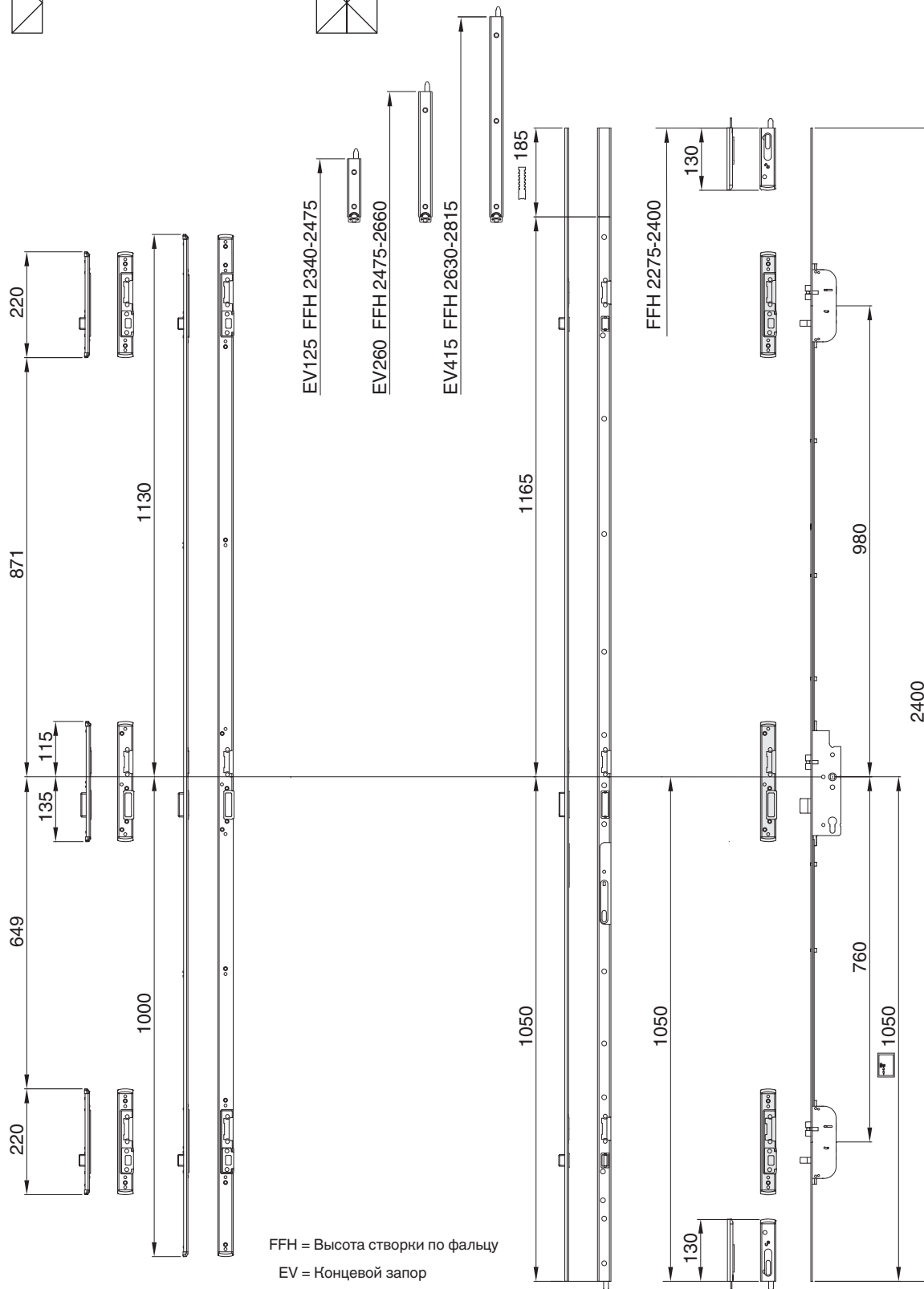

3.6 Замок Z-TF PT с фалевыми защёлками-штырями

3.6.1 E92 Штульп F-16

237154

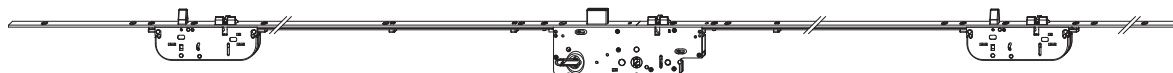

3.6.1.1 Дверной замок Z-TF PT с 2 фалевыми защёлками-штырями Штульп F-16



не удлин.

| 92 | 35 | 8 | 1.050 | 2.000 - 2.200 | 16 | 2.200 | 5 | № | € |
|----|----|----|-------|---------------|----|-------|---|--------|---|
| | | 10 | 1.050 | 2.000 - 2.200 | 16 | 2.200 | 5 | 237150 | |
| | 40 | 8 | 1.050 | 2.000 - 2.200 | 16 | 2.200 | 5 | 237151 | |
| | | 10 | 1.050 | 2.000 - 2.200 | 16 | 2.200 | 5 | 239001 | |
| | 45 | 8 | 1.050 | 2.000 - 2.200 | 16 | 2.200 | 5 | 237152 | |
| | | 10 | 1.050 | 2.000 - 2.200 | 16 | 2.200 | 5 | 239002 | |
| | 50 | 8 | 1.050 | 2.000 - 2.200 | 16 | 2.200 | 5 | 237153 | |
| | | 10 | 1.050 | 2.000 - 2.200 | 16 | 2.200 | 5 | 239003 | |
| | 55 | 8 | 1.050 | 2.000 - 2.200 | 16 | 2.200 | 5 | 237154 | |
| | | 10 | 1.050 | 2.000 - 2.200 | 16 | 2.200 | 5 | 239004 | |
| | 65 | 8 | 1.050 | 2.000 - 2.200 | 16 | 2.200 | 5 | 237155 | |
| | | 10 | 1.050 | 2.000 - 2.200 | 16 | 2.200 | 5 | 239005 | |
| | 70 | 8 | 1.050 | 2.000 - 2.200 | 16 | 2.200 | 5 | 237156 | |
| | | 10 | 1.050 | 2.000 - 2.200 | 16 | 2.200 | 5 | 239006 | |
| | 80 | 8 | 1.050 | 2.000 - 2.200 | 16 | 2.200 | 5 | 237157 | |
| | | 10 | 1.050 | 2.000 - 2.200 | 16 | 2.200 | 5 | 239007 | |

239044



3.6.1.2 Дверной замок Z-TF PT с 2 фалевыми защёлками-штырями Штульп F-16 K+605









не удлин.

| 92 | 35 | 8 | 1.050 | 1.800 - 2.000 | 16 | 2.000 | 5 | № | € |
|----|----|----|-------|---------------|----|-------|---|--------|---|
| | | 10 | 1.050 | 1.800 - 2.000 | 16 | 2.000 | 5 | 239040 | |
| | 40 | 8 | 1.050 | 1.800 - 2.000 | 16 | 2.000 | 5 | 239041 | |
| | | 10 | 1.050 | 1.800 - 2.000 | 16 | 2.000 | 5 | 239051 | |
| | 45 | 8 | 1.050 | 1.800 - 2.000 | 16 | 2.000 | 5 | 239042 | |
| | | 10 | 1.050 | 1.800 - 2.000 | 16 | 2.000 | 5 | 239052 | |
| | 50 | 8 | 1.050 | 1.800 - 2.000 | 16 | 2.000 | 5 | 239043 | |
| | | 10 | 1.050 | 1.800 - 2.000 | 16 | 2.000 | 5 | 239053 | |
| | 55 | 8 | 1.050 | 1.800 - 2.000 | 16 | 2.000 | 5 | 239044 | |
| | | 10 | 1.050 | 1.800 - 2.000 | 16 | 2.000 | 5 | 239054 | |
| | 65 | 8 | 1.050 | 1.800 - 2.000 | 16 | 2.000 | 5 | 239045 | |
| | | 10 | 1.050 | 1.800 - 2.000 | 16 | 2.000 | 5 | 239055 | |
| | 70 | 8 | 1.050 | 1.800 - 2.000 | 16 | 2.000 | 5 | 239046 | |
| | | 10 | 1.050 | 1.800 - 2.000 | 16 | 2.000 | 5 | 239056 | |
| | 80 | 8 | 1.050 | 1.800 - 2.000 | 16 | 2.000 | 5 | 239047 | |
| | | 10 | 1.050 | 1.800 - 2.000 | 16 | 2.000 | 5 | 239057 | |

239094







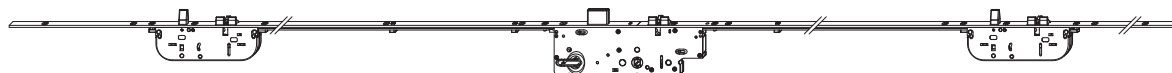

| 3.6.1.3 Дверной замок Z-TF PT с 2 фалевыми защёлками-штырями Штульп F-16 Н+980 | |  |  |  |  |  |  | L |  | № | € |
|--|----|---|---|---|---|---|--|----------|---|---------------|----------|
| не удлин. | 92 | 35 | 8 | 1.050 | 2.200 - 2.400 | | 16 | 2.400 | 5 | 239090 | |
| | | | 10 | 1.050 | 2.200 - 2.400 | | 16 | 2.400 | 5 | 239100 | |
| | 40 | | 8 | 1.050 | 2.200 - 2.400 | | 16 | 2.400 | 5 | 239091 | |
| | | | 10 | 1.050 | 2.200 - 2.400 | | 16 | 2.400 | 5 | 239101 | |
| | 45 | | 8 | 1.050 | 2.200 - 2.400 | | 16 | 2.400 | 5 | 239092 | |
| | | | 10 | 1.050 | 2.200 - 2.400 | | 16 | 2.400 | 5 | 239102 | |
| | 50 | | 8 | 1.050 | 2.200 - 2.400 | | 16 | 2.400 | 5 | 239093 | |
| | | | 10 | 1.050 | 2.200 - 2.400 | | 16 | 2.400 | 5 | 239103 | |
| | 55 | | 8 | 1.050 | 2.200 - 2.400 | | 16 | 2.400 | 5 | 239094 | |
| | | | 10 | 1.050 | 2.200 - 2.400 | | 16 | 2.400 | 5 | 239104 | |
| | 65 | | 8 | 1.050 | 2.200 - 2.400 | | 16 | 2.400 | 5 | 239095 | |
| | | | 10 | 1.050 | 2.200 - 2.400 | | 16 | 2.400 | 5 | 239105 | |
| | 70 | | 8 | 1.050 | 2.200 - 2.400 | | 16 | 2.400 | 5 | 239096 | |
| | | | 10 | 1.050 | 2.200 - 2.400 | | 16 | 2.400 | 5 | 239106 | |
| | 80 | | 8 | 1.050 | 2.200 - 2.400 | | 16 | 2.400 | 5 | 239097 | |
| | | | 10 | 1.050 | 2.200 - 2.400 | | 16 | 2.400 | 5 | 239107 | |

3.6.2 E92 Штульп F-20

239144



| 3.6.2.1 Дверной замок Z-TF PT с 2 фалевыми защёлками-штырями Штульп F-20 | |  |  |  |  |  | L |  | № | € | |
|--|----|---|---|---|---|---|----------|---|----------|---------------|--|
| не удлин. | 92 | 35 | 8 | 1.050 | 2.000 - 2.200 | | 20 | 2.200 | 5 | 239140 | |
| | | | 10 | 1.050 | 2.000 - 2.200 | | 20 | 2.200 | 5 | 239150 | |
| | 40 | | 8 | 1.050 | 2.000 - 2.200 | | 20 | 2.200 | 5 | 239141 | |
| | | | 10 | 1.050 | 2.000 - 2.200 | | 20 | 2.200 | 5 | 239151 | |
| | 45 | | 8 | 1.050 | 2.000 - 2.200 | | 20 | 2.200 | 5 | 239142 | |
| | | | 10 | 1.050 | 2.000 - 2.200 | | 20 | 2.200 | 5 | 239152 | |
| | 50 | | 8 | 1.050 | 2.000 - 2.200 | | 20 | 2.200 | 5 | 239143 | |
| | | | 10 | 1.050 | 2.000 - 2.200 | | 20 | 2.200 | 5 | 239153 | |
| | 55 | | 8 | 1.050 | 2.000 - 2.200 | | 20 | 2.200 | 5 | 239144 | |
| | | | 10 | 1.050 | 2.000 - 2.200 | | 20 | 2.200 | 5 | 239154 | |
| | 65 | | 8 | 1.050 | 2.000 - 2.200 | | 20 | 2.200 | 5 | 239145 | |
| | | | 10 | 1.050 | 2.000 - 2.200 | | 20 | 2.200 | 5 | 239155 | |
| | 70 | | 8 | 1.050 | 2.000 - 2.200 | | 20 | 2.200 | 5 | 239146 | |
| | | | 10 | 1.050 | 2.000 - 2.200 | | 20 | 2.200 | 5 | 239156 | |
| | 80 | | 8 | 1.050 | 2.000 - 2.200 | | 20 | 2.200 | 5 | 239147 | |
| | | | 10 | 1.050 | 2.000 - 2.200 | | 20 | 2.200 | 5 | 239157 | |

239194



| 3.6.2.2 Дверной замок Z-TF PT с 2 фалевыми защёлками-штырями Штульп F-20 K+605 | | | | | | | | | | | № | € |
|--|----|----|-------|---------------|---------------|-------|-------|---|--|--------|----------|----------|
| не удлин. | 92 | 35 | 8 | 1.050 | 1.800 - 2.000 | 20 | 2.000 | 5 | | | 239190 | |
| | | | 10 | 1.050 | 1.800 - 2.000 | 20 | 2.000 | 5 | | | 239200 | |
| | 40 | 8 | 1.050 | 1.800 - 2.000 | 20 | 2.000 | 5 | | | 239191 | | |
| | | | 10 | 1.050 | 1.800 - 2.000 | 20 | 2.000 | 5 | | | 239201 | |
| | 45 | 8 | 1.050 | 1.800 - 2.000 | 20 | 2.000 | 5 | | | 239192 | | |
| | | | 10 | 1.050 | 1.800 - 2.000 | 20 | 2.000 | 5 | | | 239202 | |
| | 50 | 8 | 1.050 | 1.800 - 2.000 | 20 | 2.000 | 5 | | | 239193 | | |
| | | | 10 | 1.050 | 1.800 - 2.000 | 20 | 2.000 | 5 | | | 239203 | |
| | 55 | 8 | 1.050 | 1.800 - 2.000 | 16 | 2.000 | 5 | | | 239194 | | |
| | | | 10 | 1.050 | 1.800 - 2.000 | 20 | 2.000 | 5 | | | 239204 | |
| | 65 | 8 | 1.050 | 1.800 - 2.000 | 20 | 2.000 | 5 | | | 239195 | | |
| | | | 10 | 1.050 | 1.800 - 2.000 | 20 | 2.000 | 5 | | | 239205 | |
| | 70 | 8 | 1.050 | 1.800 - 2.000 | 20 | 2.000 | 5 | | | 239196 | | |
| | | | 10 | 1.050 | 1.800 - 2.000 | 20 | 2.000 | 5 | | | 239206 | |
| | 80 | 8 | 1.050 | 1.800 - 2.000 | 20 | 2.000 | 5 | | | 239197 | | |
| | | | 10 | 1.050 | 1.800 - 2.000 | 20 | 2.000 | 5 | | | 239207 | |

239244



| 3.6.2.3 Дверной замок Z-TF PT с 2 фалевыми защёлками-штырями Штульп F-20 K+980 | | | | | | | | | | | № | € |
|--|----|----|-------|---------------|---------------|-------|-------|---|--|--------|----------|----------|
| не удлин. | 92 | 35 | 8 | 1.050 | 2.200 - 2.400 | 20 | 2.400 | 5 | | | 239240 | |
| | | | 10 | 1.050 | 2.200 - 2.400 | 20 | 2.400 | 5 | | | 239250 | |
| | 40 | 8 | 1.050 | 2.200 - 2.400 | 20 | 2.400 | 5 | | | 239241 | | |
| | | | 10 | 1.050 | 2.200 - 2.400 | 20 | 2.400 | 5 | | | 239251 | |
| | 45 | 8 | 1.050 | 2.200 - 2.400 | 20 | 2.400 | 5 | | | 239242 | | |
| | | | 10 | 1.050 | 2.200 - 2.400 | 20 | 2.400 | 5 | | | 239252 | |
| | 50 | 8 | 1.050 | 2.200 - 2.400 | 20 | 2.400 | 5 | | | 239243 | | |
| | | | 10 | 1.050 | 2.200 - 2.400 | 20 | 2.400 | 5 | | | 239253 | |
| | 55 | 8 | 1.050 | 2.200 - 2.400 | 20 | 2.400 | 5 | | | 239244 | | |
| | | | 10 | 1.050 | 2.200 - 2.400 | 20 | 2.400 | 5 | | | 239254 | |
| | 65 | 8 | 1.050 | 2.200 - 2.400 | 20 | 2.400 | 5 | | | 239245 | | |
| | | | 10 | 1.050 | 2.200 - 2.400 | 20 | 2.400 | 5 | | | 239255 | |
| | 70 | 8 | 1.050 | 2.200 - 2.400 | 20 | 2.400 | 5 | | | 239246 | | |
| | | | 10 | 1.050 | 2.200 - 2.400 | 20 | 2.400 | 5 | | | 239256 | |
| | 80 | 8 | 1.050 | 2.200 - 2.400 | 20 | 2.400 | 5 | | | 239247 | | |
| | | | 10 | 1.050 | 2.200 - 2.400 | 20 | 2.400 | 5 | | | 239257 | |

3.6.3 E92 Штульп F-24

237324



3.6.3.1 Дверной замок Z-TF PT
с 2 фалевыми защёлками-
штырями Штульп F-24

не удлин.

| | | | | | | | L | | № | € |
|----|----|----|-------|---------------|----|-------|---|--------|---|---|
| 92 | 35 | 8 | 1.050 | 2.000 - 2.200 | 24 | 2.200 | 5 | 237320 | | |
| | | 10 | 1.050 | 2.000 - 2.200 | 24 | 2.200 | 5 | 237330 | | |
| 40 | 8 | 8 | 1.050 | 2.000 - 2.200 | 24 | 2.200 | 5 | 237321 | | |
| | | 10 | 1.050 | 2.000 - 2.200 | 24 | 2.200 | 5 | 237331 | | |
| 45 | 8 | 8 | 1.050 | 2.000 - 2.200 | 24 | 2.200 | 5 | 237322 | | |
| | | 10 | 1.050 | 2.000 - 2.200 | 24 | 2.200 | 5 | 237332 | | |
| 50 | 8 | 8 | 1.050 | 2.000 - 2.200 | 24 | 2.200 | 5 | 237323 | | |
| | | 10 | 1.050 | 2.000 - 2.200 | 24 | 2.200 | 5 | 237333 | | |
| 55 | 8 | 8 | 1.050 | 2.000 - 2.200 | 24 | 2.200 | 5 | 237324 | | |
| | | 10 | 1.050 | 2.000 - 2.200 | 24 | 2.200 | 5 | 237334 | | |
| 65 | 8 | 8 | 1.050 | 2.000 - 2.200 | 24 | 2.200 | 5 | 237325 | | |
| | | 10 | 1.050 | 2.000 - 2.200 | 24 | 2.200 | 5 | 237335 | | |
| 70 | 8 | 8 | 1.050 | 2.000 - 2.200 | 24 | 2.200 | 5 | 237326 | | |
| | | 10 | 1.050 | 2.000 - 2.200 | 24 | 2.200 | 5 | 237336 | | |
| 80 | 8 | 8 | 1.050 | 2.000 - 2.200 | 24 | 2.200 | 5 | 237327 | | |
| | | 10 | 1.050 | 2.000 - 2.200 | 24 | 2.200 | 5 | 237337 | | |

237374



3.6.3.2 Дверной замок Z-TF PT
с 2 фалевыми защёлками-
штырями Штульп F-24 H+605

не удлин.

| | | | | | | | L | | № | € |
|----|----|----|-------|---------------|----|-------|---|--------|---|---|
| 92 | 35 | 8 | 1.050 | 1.800 - 2.000 | 24 | 2.000 | 5 | 237370 | | |
| | | 10 | 1.050 | 1.800 - 2.000 | 24 | 2.000 | 5 | 237380 | | |
| 40 | 8 | 8 | 1.050 | 1.800 - 2.000 | 24 | 2.000 | 5 | 237371 | | |
| | | 10 | 1.050 | 1.800 - 2.000 | 24 | 2.000 | 5 | 237381 | | |
| 45 | 8 | 8 | 1.050 | 1.800 - 2.000 | 24 | 2.000 | 5 | 237372 | | |
| | | 10 | 1.050 | 1.800 - 2.000 | 24 | 2.000 | 5 | 237382 | | |
| 50 | 8 | 8 | 1.050 | 1.800 - 2.000 | 24 | 2.000 | 5 | 237373 | | |
| | | 10 | 1.050 | 1.800 - 2.000 | 24 | 2.000 | 5 | 237383 | | |
| 55 | 8 | 8 | 1.050 | 1.800 - 2.000 | 24 | 2.000 | 5 | 237374 | | |
| | | 10 | 1.050 | 1.800 - 2.000 | 24 | 2.000 | 5 | 237384 | | |
| 65 | 8 | 8 | 1.050 | 1.800 - 2.000 | 24 | 2.000 | 5 | 237375 | | |
| | | 10 | 1.050 | 1.800 - 2.000 | 24 | 2.000 | 5 | 237385 | | |
| 70 | 8 | 8 | 1.050 | 1.800 - 2.000 | 24 | 2.000 | 5 | 237376 | | |
| | | 10 | 1.050 | 1.800 - 2.000 | 24 | 2.000 | 5 | 237386 | | |
| 80 | 8 | 8 | 1.050 | 1.800 - 2.000 | 24 | 2.000 | 5 | 237377 | | |
| | | 10 | 1.050 | 1.800 - 2.000 | 24 | 2.000 | 5 | 237387 | | |

237394

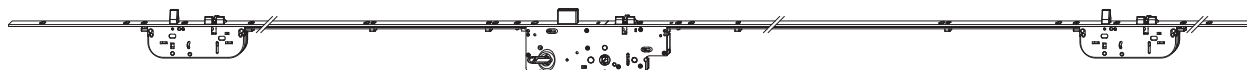

3.6.3.3 Дверной замок Z-TF PT с 2 фалевыми защёлками-штырями Штульп F-24 K+980

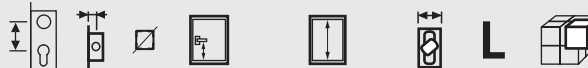

№

€

не удлин.

| 92 | 35 | 8 | 1.050 | 2.200 - 2.400 | 24 | 2.400 | 5 | 237390 |
|----|----|----|-------|---------------|----|-------|---|--------|
| | | 10 | 1.050 | 2.200 - 2.400 | 24 | 2.400 | 5 | 237400 |
| | 40 | 8 | 1.050 | 2.200 - 2.400 | 24 | 2.400 | 5 | 237391 |
| | | 10 | 1.050 | 2.200 - 2.400 | 24 | 2.400 | 5 | 237401 |
| | 45 | 8 | 1.050 | 2.200 - 2.400 | 24 | 2.400 | 5 | 237392 |
| | | 10 | 1.050 | 2.200 - 2.400 | 24 | 2.400 | 5 | 237402 |
| | 50 | 8 | 1.050 | 2.200 - 2.400 | 24 | 2.400 | 5 | 237393 |
| | | 10 | 1.050 | 2.200 - 2.400 | 24 | 2.400 | 5 | 237403 |
| | 55 | 8 | 1.050 | 2.200 - 2.400 | 24 | 2.400 | 5 | 237394 |
| | | 10 | 1.050 | 2.200 - 2.400 | 24 | 2.400 | 5 | 237404 |
| | 65 | 8 | 1.050 | 2.200 - 2.400 | 24 | 2.400 | 5 | 237395 |
| | | 10 | 1.050 | 2.200 - 2.400 | 24 | 2.400 | 5 | 237405 |
| | 70 | 8 | 1.050 | 2.200 - 2.400 | 24 | 2.400 | 5 | 237396 |
| | | 10 | 1.050 | 2.200 - 2.400 | 24 | 2.400 | 5 | 237406 |
| | 80 | 8 | 1.050 | 2.200 - 2.400 | 24 | 2.400 | 5 | 237397 |
| | | 10 | 1.050 | 2.200 - 2.400 | 24 | 2.400 | 5 | 237407 |

3.6.4 E92 Штульп F-24/16 Hutstulp

239324

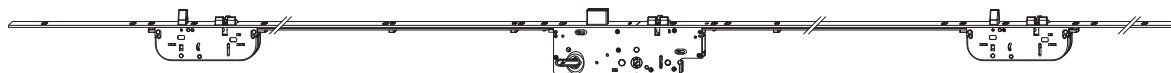

3.6.4.1 Дверной замок Z-TF PT с 2 фалевыми защёлками-штырями Штульп F-24/16



№

€

не удлин.

| 92 | 35 | 8 | 1.050 | 2.000 - 2.200 | 24 | 2.200 | 5 | 239320 |
|----|----|----|-------|---------------|----|-------|---|--------|
| | | 10 | 1.050 | 2.000 - 2.200 | 24 | 2.200 | 5 | 239330 |
| | 40 | 8 | 1.050 | 2.000 - 2.200 | 24 | 2.200 | 5 | 239321 |
| | | 10 | 1.050 | 2.000 - 2.200 | 24 | 2.200 | 5 | 239331 |
| | 45 | 8 | 1.050 | 2.000 - 2.200 | 24 | 2.200 | 5 | 239322 |
| | | 10 | 1.050 | 2.000 - 2.200 | 24 | 2.200 | 5 | 239332 |
| | 50 | 8 | 1.050 | 2.000 - 2.200 | 24 | 2.200 | 5 | 239323 |
| | | 10 | 1.050 | 2.000 - 2.200 | 24 | 2.200 | 5 | 239333 |
| | 55 | 8 | 1.050 | 2.000 - 2.200 | 24 | 2.200 | 5 | 239324 |
| | | 10 | 1.050 | 2.000 - 2.200 | 24 | 2.200 | 5 | 239334 |
| | 65 | 8 | 1.050 | 2.000 - 2.200 | 24 | 2.200 | 5 | 239325 |
| | | 10 | 1.050 | 2.000 - 2.200 | 24 | 2.200 | 5 | 239335 |
| | 70 | 8 | 1.050 | 2.000 - 2.200 | 24 | 2.200 | 5 | 239326 |
| | | 10 | 1.050 | 2.000 - 2.200 | 24 | 2.200 | 5 | 239336 |
| | 80 | 8 | 1.050 | 2.000 - 2.200 | 24 | 2.200 | 5 | 239327 |
| | | 10 | 1.050 | 2.000 - 2.200 | 24 | 2.200 | 5 | 239337 |

239374



| 3.6.4.2 Дверной замок Z-TF PT с 2 фалевыми защёлками-штырями Штульп F-24/16 K+605 | | | | | | | | L | | № | € |
|---|----|----|-------|---------------|---------------|-------|-------|----------|--------|----------|----------|
| не удлин. | 92 | 35 | 8 | 1.050 | 1.800 - 2.000 | 24 | 2.000 | 5 | 239370 | | |
| | | | 10 | 1.050 | 1.800 - 2.000 | 24 | 2.000 | 5 | 239380 | | |
| | 40 | 8 | 1.050 | 1.800 - 2.000 | 24 | 2.000 | 5 | 239371 | | | |
| | | 10 | 1.050 | 1.800 - 2.000 | 24 | 2.000 | 5 | 239381 | | | |
| | 45 | 8 | 1.050 | 1.800 - 2.000 | 24 | 2.000 | 5 | 239372 | | | |
| | | 10 | 1.050 | 1.800 - 2.000 | 24 | 2.000 | 5 | 239382 | | | |
| | 50 | 8 | 1.050 | 1.800 - 2.000 | 24 | 2.000 | 5 | 239373 | | | |
| | | 10 | 1.050 | 1.800 - 2.000 | 24 | 2.000 | 5 | 239383 | | | |
| | 55 | 8 | 1.050 | 1.800 - 2.000 | 24 | 2.000 | 5 | 239374 | | | |
| | | 10 | 1.050 | 1.800 - 2.000 | 24 | 2.000 | 5 | 239384 | | | |
| | 65 | 8 | 1.050 | 1.800 - 2.000 | 24 | 2.000 | 5 | 239375 | | | |
| | | 10 | 1.050 | 1.800 - 2.000 | 24 | 2.000 | 5 | 239385 | | | |
| | 70 | 8 | 1.050 | 1.800 - 2.000 | 24 | 2.000 | 5 | 239376 | | | |
| | | 10 | 1.050 | 1.800 - 2.000 | 24 | 2.000 | 5 | 239386 | | | |
| | 80 | 8 | 1.050 | 1.800 - 2.000 | 24 | 2.000 | 5 | 239377 | | | |
| | | 10 | 1.050 | 1.800 - 2.000 | 24 | 2.000 | 5 | 239387 | | | |

239424



| 3.6.4.3 Дверной замок Z-TF PT с 2 фалевыми защёлками-штырями Штульп F-24/16 K+980 | | | | | | | | L | | № | € |
|---|----|----|-------|---------------|---------------|-------|-------|----------|--------|----------|----------|
| не удлин. | 92 | 35 | 8 | 1.050 | 2.200 - 2.400 | 24 | 2.400 | 5 | 239420 | | |
| | | | 10 | 1.050 | 2.200 - 2.400 | 24 | 2.400 | 5 | 239430 | | |
| | 40 | 8 | 1.050 | 2.200 - 2.400 | 24 | 2.400 | 5 | 239421 | | | |
| | | 10 | 1.050 | 2.200 - 2.400 | 24 | 2.400 | 5 | 239431 | | | |
| | 45 | 8 | 1.050 | 2.200 - 2.400 | 24 | 2.400 | 5 | 239422 | | | |
| | | 10 | 1.050 | 2.200 - 2.400 | 24 | 2.400 | 5 | 239432 | | | |
| | 50 | 8 | 1.050 | 2.200 - 2.400 | 24 | 2.400 | 5 | 239423 | | | |
| | | 10 | 1.050 | 2.200 - 2.400 | 24 | 2.400 | 5 | 239433 | | | |
| | 55 | 8 | 1.050 | 2.200 - 2.400 | 24 | 2.400 | 5 | 239424 | | | |
| | | 10 | 1.050 | 2.200 - 2.400 | 24 | 2.400 | 5 | 239434 | | | |
| | 65 | 8 | 1.050 | 2.200 - 2.400 | 24 | 2.400 | 5 | 239425 | | | |
| | | 10 | 1.050 | 2.200 - 2.400 | 24 | 2.400 | 5 | 239435 | | | |
| | 70 | 8 | 1.050 | 2.200 - 2.400 | 24 | 2.400 | 5 | 239426 | | | |
| | | 10 | 1.050 | 2.200 - 2.400 | 24 | 2.400 | 5 | 239436 | | | |
| | 80 | 8 | 1.050 | 2.200 - 2.400 | 24 | 2.400 | 5 | 239427 | | | |
| | | 10 | 1.050 | 2.200 - 2.400 | 24 | 2.400 | 5 | 239437 | | | |

3.6.5 E92 U-Штульп 6x24x6 GM1050

237012

3.6.5.1 Дверной замок Z-TF PT с 2 фалевыми защёлками-штырями Штульп U-6x24x6



| не удлин. | 92 | 35 | 8 | 1.050 | 1.950 - 2.200 | 24 | 2.200 | 5 | № | € | |
|-----------|----|----|---|-------|---------------|---------------|-------|-------|--------|--------|--|
| | | | | 10 | 1.050 | 1.950 - 2.200 | 24 | 2.200 | 5 | 237010 | |
| | | | | 10 | 1.050 | 1.950 - 2.200 | 24 | 2.200 | 5 | 237180 | |
| | | 40 | 8 | 1.050 | 1.950 - 2.200 | 24 | 2.200 | 5 | 237011 | | |
| | | | | 10 | 1.050 | 1.950 - 2.200 | 24 | 2.200 | 5 | 237181 | |
| | | 45 | 8 | 1.050 | 1.950 - 2.200 | 24 | 2.200 | 5 | 237012 | | |
| | | | | 10 | 1.050 | 1.950 - 2.200 | 24 | 2.200 | 5 | 237182 | |

237222

3.6.5.2 Дверной замок Z-TF PT с 2 фалевыми защёлками-штырями Штульп U-6x24x6 K+605



| не удлин. | 92 | 35 | 8 | 1.050 | 1.800 - 2.000 | 24 | 2.200 | 5 | № | € | |
|-----------|----|----|---|-------|---------------|---------------|-------|-------|--------|--------|--|
| | | | | 10 | 1.050 | 1.800 - 2.000 | 24 | 2.200 | 5 | 237220 | |
| | | | | 10 | 1.050 | 1.800 - 2.000 | 24 | 2.200 | 5 | 237230 | |
| | | 40 | 8 | 1.050 | 1.800 - 2.000 | 24 | 2.200 | 5 | 237221 | | |
| | | | | 10 | 1.050 | 1.800 - 2.000 | 24 | 2.200 | 5 | 237231 | |
| | | 45 | 8 | 1.050 | 1.800 - 2.000 | 24 | 2.200 | 5 | 237222 | | |
| | | | | 10 | 1.050 | 1.800 - 2.000 | 24 | 2.200 | 5 | 237232 | |

237272

3.6.5.3 Дверной замок Z-TF PT с 2 фалевыми защёлками-штырями Штульп U-6x24x6 K+980



| не удлин. | 92 | 35 | 8 | 1.050 | 2.200 - 2.400 | 24 | 2.200 | 5 | № | € | |
|-----------|----|----|---|-------|---------------|---------------|-------|-------|--------|--------|--|
| | | | | 10 | 1.050 | 2.200 - 2.400 | 24 | 2.200 | 5 | 237270 | |
| | | | | 10 | 1.050 | 2.200 - 2.400 | 24 | 2.200 | 5 | 237280 | |
| | | 40 | 8 | 1.050 | 2.200 - 2.400 | 24 | 2.200 | 5 | 237271 | | |
| | | | | 10 | 1.050 | 2.200 - 2.400 | 24 | 2.200 | 5 | 237281 | |
| | | 45 | 8 | 1.050 | 2.200 - 2.400 | 24 | 2.200 | 5 | 237272 | | |
| | | | | 10 | 1.050 | 2.200 - 2.400 | 24 | 2.200 | 5 | 237282 | |





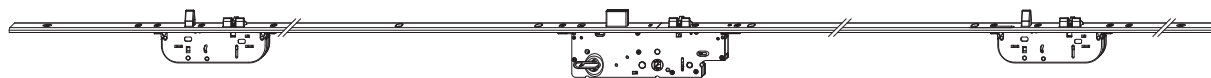







3.6.6 E92 U-Штульп U-6x24x6 GM1020

235022



3.6.6.1 Дверной замок Z-TF PT
с 2 фалевыми защёлками-
штырями Штульп U-6x24x6x

не удлин. GM 1020













|  |  |  |  |  |  |  |  |  |  |  |  |  |
|---|---|---|---|---|--|---|---|---|---|---|---|---|
| 92 | 35 | 8 | 1.020 | 1.950 - 2.200 | 24 | 2.200 | 5 | 235020 | € | | | |
| | | 10 | 1.020 | 1.950 - 2.200 | 24 | 2.200 | 5 | 235030 | | | | |
| | 40 | 8 | 1.020 | 1.950 - 2.200 | 24 | 2.200 | 5 | 235021 | | | | |
| | | 10 | 1.020 | 1.950 - 2.200 | 24 | 2.200 | 5 | 235031 | | | | |
| | 45 | 8 | 1.020 | 1.950 - 2.200 | 24 | 2.200 | 5 | 235022 | | | | |
| | | 10 | 1.020 | 1.950 - 2.200 | 24 | 2.200 | 5 | 235032 | | | | |

235042



3.6.6.2 Дверной замок Z-TF PT
с 2 фалевыми защёлками-
штырями Штульп U-6x24x6
K+605

не удлин. GM 1020













|  |  |  |  |  |  |  |  |  |  |  |  |  |
|---|---|---|---|---|--|---|---|---|---|---|---|---|
| 92 | 35 | 8 | 1.020 | 1.800 - 2.200 | 24 | 2.200 | 5 | 235040 | € | | | |
| | | 10 | 1.020 | 1.800 - 2.200 | 24 | 2.200 | 5 | 235050 | | | | |
| | 40 | 8 | 1.020 | 1.800 - 2.200 | 24 | 2.200 | 5 | 235041 | | | | |
| | | 10 | 1.020 | 1.800 - 2.200 | 24 | 2.200 | 5 | 235051 | | | | |
| | 45 | 8 | 1.020 | 1.800 - 2.200 | 24 | 2.200 | 5 | 235042 | | | | |
| | | 10 | 1.020 | 1.800 - 2.200 | 24 | 2.200 | 5 | 235052 | | | | |

235062



3.6.6.3 ТүгДверной замок Z-TF PT с 2
фалевыми защёлками-штырями
Штульп U-6x24x6 K+980

не удлин. GM 1020

|  |  |  |  |  |  |  |  |  |  |  |  |  |
|---|---|---|---|---|--|---|---|---|---|---|---|---|
| 92 | 35 | 8 | 1.020 | 2.200 - 2.400 | 24 | 2.200 | 5 | 235060 | € | | | |
| | | 10 | 1.020 | 2.200 - 2.400 | 24 | 2.200 | 5 | 240000 | | | | |
| | 40 | 8 | 1.020 | 2.200 - 2.400 | 24 | 2.200 | 5 | 235061 | | | | |
| | | 10 | 1.020 | 2.200 - 2.400 | 24 | 2.200 | 5 | 240001 | | | | |
| | 45 | 8 | 1.020 | 2.200 - 2.400 | 24 | 2.200 | 5 | 235062 | | | | |
| | | 10 | 1.020 | 2.200 - 2.400 | 24 | 2.200 | 5 | 240002 | | | | |



4 Запорные планки и штульпы запорных планок



| | | |
|-----|---|----|
| 4.1 | Запорные планки для замков G-TS PT _____ | 84 |
| 4.2 | Запорные планки для ПВХ под замки Z-TS Modul PT-M _____ | 90 |
| 4.3 | Запорные планки для ПВХ под замки Z-TF PT _____ | 94 |

4 Запорные планки и шульпы запорных планок

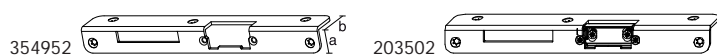

4.1 Запорные планки для замков G-TS PT

4.1.1 Запорные планки для дерева



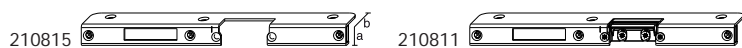

| 4.1.1.1 Угловая фалевая - ригельная запорная пластина, фальцлюфт 4 мм | |  |  | № | € |
|--|-------|---|---|--------|---|
| Угловая фалев.-ригельная запорная планка для электр. открывания дерево/ПВХ | лев. | 25 x 32 | 20 | 354954 | |
| | прав. | 25 x 32 | 20 | 354952 | |
| Угловая фалев.-ригельная запорная планка под защелку фальцлюфт 4 мм | лев. | 25 x 32 | 20 | 203503 | |
| | прав. | 25 x 32 | 20 | 203502 | |





| 4.1.1.2 Угловая фалевая - ригельная запорная пластина, фальцлюфт 12 мм | |  |  | № | € |
|---|-------|---|---|--------|---|
| Угловая фалев.-ригельная запорная планка для электр. открывания фальц 18 мм | лев. | 18 x 32 | 20 | 210814 | |
| | прав. | 18 x 32 | 20 | 210813 | |
| Угловая фалев.-ригельная запорная планка для электр. открывания фальц 20 мм | лев. | 20 x 32 | 20 | 210816 | |
| | прав. | 20 x 32 | 20 | 210815 | |
| Угловая фалев.-ригельная запорная планка под защелку фальц 18 мм | лев. | 18 x 32 | 20 | 210810 | |
| | прав. | 18 x 32 | 20 | 210809 | |
| Угловая фалев.-ригельная запорная планка под защелку фальц 20 мм | лев. | 20 x 32 | 20 | 210812 | |
| | прав. | 20 x 32 | 20 | 210811 | |





| 4.1.1.3 Фалевая - ригельная запорная планка | |  |  | № | € |
|---|-------|---|---|-------|---|
| Фалев.-ригельная запорная планка | | 16 | 20 | 55987 | |
| Фалев.-ригельная запорная планка паз 6/8/4 | лев. | 16 | 50 | 58647 | |
| | прав. | 16 | 50 | 58646 | |
| Фалев.-ригельная запорная планка паз 7/8/4 | лев. | 16 | 50 | 58649 | |
| | прав. | 16 | 20 | 58648 | |
| Фалев.-ригельная запорная планка фальцлюфт 4 мм | | 16 | 20 | 29776 | |
| | | 20 | 20 | 29787 | |





| 4.1.1.4 Фалевая запорная планка | |  |  | № | € |
|--|----------|---|---|--------|---|
| Запорная планка под фалевую защелку фальцлюфт 4 мм | лев/прав | 16 | 20 | 210501 | |
| | | 20 | 20 | 210502 | |





| 4.1.1.5 Фалевая - ригельная запорная планка для роликовой защёлки, фальцлюфт 4 мм | |  |  | № | € |
|---|-------|---|---|-------|---|
| Фалевая-ригельная запорная планка под ролик. защелку фальцлюфт 4 мм | лев. | 16 | 10 | 59420 | |
| | прав. | 16 | 10 | 59421 | |





| 4.1.1.6 Запорная планка под крюки | |  |  | № | € |
|--|---|---|---|-------|---|
| Запорная планка под крюки паз 7/8/4 | . | 16 | 20 | 29986 | |
| Запорная планка под крюки фальц 18 мм | . | 16 | 20 | 29985 | |
| Запорная планка под крюки фальцлюфт 4 мм | . | 16 | 20 | 29979 | |
| | | 20 | 20 | 29980 | |





| 4.1.1.7 Запорная планка под шуры | |  |  | № | € |
|---|---|---|---|-------|---|
| Запорная планка под шуры | . | 16 | 20 | 58667 | |
| Запорная планка под шуры паз 7/8/4 | . | 16 | 20 | 26617 | |
| Запорная планка под шуры фальцлюфт 4 мм | . | 16 | 20 | 26799 | |
| | | 20 | 20 | 29788 | |





| 4.1.1.8 Запорная планка | |  |  | № | € |
|--------------------------------|----------|--|--|-------|---|
| Запорная планка паз 6/8/4 | . | 16 | 200 | 34921 | |
| | приж - 1 | 16 | 200 | 34979 | |
| Запорная планка паз 7/8/4 | . | 16 | 200 | 34902 | |
| | приж - 1 | 16 | 200 | 34969 | |
| Запорная планка фальц 18 мм | . | 16 | 200 | 34980 | |
| Запорная планка фальцлюфт 4 мм | . | 16 | 200 | 30545 | |
| | | 20 | 50 | 34004 | |



| 4.1.1.9 Взломостойкая запорная планка i.S. | |  |  | № | € |
|--|-------|---|---|-------|---|
| Запорная планка iS паз 6/8/4 | . | 16 | 100 | 96563 | |
| Запорная планка iS паз 7/8/4 | . | 16 | 100 | 96564 | |
| Запорная планка iS фальц 18 мм | . | 16 | 100 | 96860 | |
| Запорная планка iS фальцлюфт 4 мм | лев. | 16 | 100 | 96566 | |
| | | 20 | 100 | 96846 | |
| | прав. | 16 | 100 | 96565 | |
| | | 20 | 100 | 96845 | |



| 4.1.1.10 Ригельная запорная планка с 2 пазами | |  |  | № | € |
|---|---|---|---|-------|---|
| Ригельная запорная планка с 2 пазами | . | 16 | 20 | 55986 | |
| Ригельная запорная планка с 2 пазами паз 7/8/4 | . | 16 | 20 | 50579 | |
| Ригельная запорная планка с 2 пазами фальцлюфт 4 мм | . | 16 | 20 | 50576 | |



| 4.1.1.11 Декоративная накладка для запорной планки | |  | № | € |
|---|---------------|---|--------|---|
| Конц. подкладка для запорной планки фальц 20 мм | Цвет: Серебро | 100 | 354358 | |
| Конц. подкладка для фалевой запорной планки фальц 18 мм | | 100 | 360074 | |

43718



4.1.1.12 Декоративная накладка для запорной планки роликовой защёлки



№

€

Конц. подкладка для запорной планки и шпингалета фальц 18 мм

Цвет: Серебро

100

43718

42586

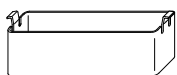

41250



42587

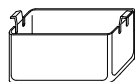

43524

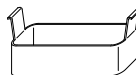

4.1.1.13 Декоративная вставка



№

€

Накладка для запорной планки под крюки Цвет: серебро

50

42586

Накладка для запорной планки под штыри Цвет: серебро

50

41250

Накладка для ригельной запорной планки с 2 пазами Цвет: серебро

50

42587













Накладка для фалево-ригельной запорной планки дерево Цвет: серебро

50

43524

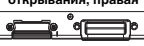
4.1.2 Запорные планки для ПВХ

4.1.2.1 Серия ZA

| | | | |
|---|---|--|--------|
| Профили | Декоративная вставка | Ригельная запорная планка | 355403 |
| |  | Ригельная запорная планка с 2 шлицами ZA | 206934 |
| Декоративная вставка | Запорная планка под штырь | Запорная планка под штырь ZA | 355399 |
| |  |  | 206910 |
| Декоративная вставка | Запорная планка под крюк | Запорная планка под крюк ZA | 355401 |
| |  |  | 206901 |
| Взломостойкая запорная планка i.S. левая, ZA |  | Взломостойкая запорная планка i.S. правая, ZA | 357362 |
| |  |  | 357361 |
| Фалевая-ригельная запор. планка, взломостой.* для электронного открывания, левая |  | Фалевая-ригельная запор. планка, взломостой.* для электронного открывания, правая | 209090 |
| |  |  | 209089 |
| Фалевая-ригельная запор. планка, взломостой.* с эксцентриком, левая |  | Фалевая-ригельная запор. планка, взломостой.* с эксцентриком, правая | 209087 |
| |  |  | 209086 |
| Alphacan Class | | | |
| Aluplast 2000 | | | |
| Aluplast 4000 | | | |
| Aluplast 5000 | | | |
| Beschlagnut gegenüber | | | |
| Brüggmann AD | | | |
| Brüggmann AD 20mm Vers. | | | |
| Decumnick 800 21mm Vers. | | | |
| Decumnick Z endow | | | |
| Dimex Komfort | | | |
| Duralflex X 3500 | | | |
| Gealan S 3000 | | | |
| Gealan S 7000 | | | |
| Gealan S 8000 | | | |
| Greiner Intertec | | | |
| KBE System 70 AD | | | |
| Kömmering Eurodur 35 | | | |
| Kömmering Eurofutur | | | |
| Kömmering Eurofutur MD | | | |
| Kömmering Gold 70 | | | |
| Rehau S 730 | | | |
| Rehau S 706 New | | | |
| Rehau Tritec | | | |
| Salamander 2D | | | |
| Salamander 3D | | | |
| Schüco Corona AS | | | |
| Schüco CT 70 - AS | | | |
| Schüco CT 70 - MD | | | |
| Schüco SI 82 | | | |
| Thyssen AD | | | |
| Thyssen Prestige | | | |
| Trocal Innovova A3 | | | |
| Trocal Innovova A5 | | | |
| Trocal Innovova Confort | | | |
| Veka Softline | | | |
| Veka T opline | | | |
| Wymar Profex 2500 | | | |
| Wymar Profex 3000 | | | |
| Wymar Profex 3000 aussendr. | | | |

*Взломостойкая (усиленная стальная пластина в области запорного ригеля)

4.1.2.2 Серия U-профиль

| | | |
|---------|--|--------|
| | Декоративная вставка | 355403 |
| | Ригельная запорная планка | 355403 |
| | Ригельная запорная планка с 2 шлицами ZA | 206923 |
| | | 206931 |
| | Декоративная вставка | 355399 |
| | Запорная планка под штырь | 355399 |
| | Запорная планка под штырь, U-Профиль | 207139 |
| | | 207151 |
| | Декоративная вставка | 355401 |
| | Запорная планка под штырь | 355401 |
| | Запорная планка под штырь, U-Профиль | 207155 |
| | | 207159 |
| | Декоративная вставка | 355401 |
| | Запорная планка под крюк | 355401 |
| | Запорная планка под крюк, U-профиль | 207138 |
| | | 207150 |
| | Взломостойкая запорная планка i.S. левая, U-профиль | 207141 |
| | | 207153 |
| | Взломостойкая запорная планка i.S. правая, U-профиль | 207140 |
| | | 207152 |
| | Фалевая-ригельная запор. планка, взломостой.* для электронного открывания, левая | 209095 |
| | | 209100 |
| | Фалевая-ригельная запор. планка, взломостой.* для электронного открывания, левая | 209094 |
| | | 209099 |
| | Фалевая-ригельная запор. планка, взломостой.* с эксцентриком, левая | 209092 |
| | | 209097 |
| | Фалевая-ригельная запор. планка, взломостой.* с эксцентриком, правая | 209091 |
| | | 209096 |
| Профили | Aluplast 2000 | 209100 |
| | Aluplast 4000 | 209099 |
| | Aluplast 5000 | 209099 |
| | Beschlagsnut gegenüber | 209104 |
| | Brügmann AD | 209109 |
| | Brügmann AD 20V | 209114 |
| | Dimex Komfort | 209099 |
| | Duraflex X 3500 | 209129 |
| | Gealan S 3000 | 209134 |
| | Gealan S 7000 | 209134 |
| | KBE System 70 AD | 209139 |
| | Kömmelring Eurodur 3S | 209144 |
| | Kömmelring Eurofur | 209144 |
| | Kömmelring Gold 70 | 209137 |
| | Rehau S 730 | 209157 |
| | Rehau S706 New | 209161 |
| | Rehau Tritec | 209161 |
| | Salamander 2D | 209166 |
| | Salamander 3D | 209166 |
| | Schüco CT 70 - AS | 209091 |
| | Schüco Si 82 | 209091 |
| | Thyssen AD | 209176 |
| | Thyssen Prestige | 209176 |
| | Trocal Innova A3 | 209181 |
| | Trocal Innova A5 | 209181 |
| | Trocal Innova Comfort | 209181 |
| | Veka Topline | 209106 |

*Взломостойкая (усиленная стальная пластина в области запорного ригеля)

4.1.2.3 Шульпы запорных планок









| Profile | Шульпа для 4 взломостойких i.S. запорных планок, правый | Шульпа для 4 взломостойких i.S. запорных планок, левый | Шульпа для 2 запорных планок под крючки, правый | Шульпа для 2 запорных планок под крючки, левый | Шульпа для 2 запорных планок под шульпы, правый | Шульпа для 2 запорных планок под шульпы, левый | Шульпа для 3 взломостойких i.S. запорных планок и дополнительного замка, правый | Шульпа для 3 взломостойких i.S. запорных планок и дополнительного замка, левый | Шульпа для 2 запорных планок под крючки и дополнительного замка, правый | Шульпа для 2 запорных планок под крючки и дополнительного замка, левый | Шульпа для 2 запорных планок под шульпы и дополнительного замка, правый | Шульпа для 2 запорных планок под шульпы и дополнительного замка, левый | Запорная планка под крюк и дополнительный замок | Запорная планка под шульпу | Декоративная вставка |
|----------------------------------|---|--|---|--|---|--|---|--|---|--|---|--|---|----------------------------|----------------------|
| Alphacan MD | 213984 | 213984 | - | - | - | - | - | - | - | - | - | - | - | - | - |
| Aluplast 2000 | 208536 | 208535 | 208533 | 208532 | 208531 | - | - | - | - | - | - | - | 355399 | 355399 | - |
| Aluplast 4000 | 208550 | 208549 | 208547 | 208546 | 208544 | 208542 | 208541 | 208538 | 208537 | 208537 | 208538 | 208537 | 355399 | 355399 | - |
| Aluplast 5000 | 208550 | 208549 | 208547 | 208546 | 208544 | 208542 | 208541 | 208538 | 208537 | 208537 | 208538 | 208537 | 355399 | 355399 | - |
| Beschlagsnut gegenüber | 208598 | 208597 | 208595 | 208594 | 208593 | 208592 | 208591 | 208588 | 208587 | 208587 | 208588 | 208587 | 355399 | 355399 | - |
| Brüggmann AD | 208586 | 208584 | 208583 | 208582 | 208581 | 208580 | 208579 | 208576 | 208575 | 208575 | 208576 | 208575 | 355399 | 355399 | - |
| Dimec Komfort | 208550 | 208549 | 208547 | 208546 | 208544 | 208542 | 208541 | 208538 | 208537 | 208537 | 208538 | 208537 | 355399 | 355399 | - |
| Gealan S 3000 | 207853 | 207852 | 207846 | 207845 | 207844 | 207839 | 207838 | 207835 | 207834 | 207834 | 207835 | 207834 | 355399 | 355399 | - |
| Gealan S 7000 | 207853 | 207852 | 207846 | 207845 | 207844 | 207839 | 207838 | 207835 | 207834 | 207834 | 207835 | 207834 | 355399 | 355399 | - |
| Gealan S 8000 | 207853 | 207852 | 207846 | 207845 | 207844 | 207839 | 207838 | 207835 | 207834 | 207834 | 207835 | 207834 | 355399 | 355399 | - |
| Kömmerring Eurodur 35 | 208562 | 208561 | 208559 | 208558 | 208557 | 208556 | 208555 | 208552 | 208551 | 208551 | 208552 | 208551 | 355399 | 355399 | - |
| Kömmerring Eurofutur | 208562 | 208561 | 208559 | 208558 | 208557 | 208556 | 208555 | 208552 | 208551 | 208551 | 208552 | 208551 | 355399 | 355399 | - |
| Kömmerring 88+ MD | 208609 | 208610 | - | - | - | - | - | - | - | - | - | - | - | - | - |
| Rehau S 730 | 208574 | 208573 | 208571 | 208570 | 208569 | 208568 | 208567 | 208564 | 208563 | 208563 | 208564 | 208563 | 355399 | 355399 | - |
| Salamander 2D | 208511 | 208510 | 208508 | 208507 | 208506 | 208505 | 208504 | 208501 | 208500 | 208500 | 208501 | 208500 | 355399 | 355399 | - |
| Salamander 3D | 208511 | 208510 | 208508 | 208507 | 208506 | 208505 | 208504 | 208501 | 208500 | 208500 | 208501 | 208500 | 355399 | 355399 | - |
| Schüco CT 70 - AS | 208536 | 208535 | 208533 | 208532 | 208531 | 208530 | 208529 | 208526 | 208525 | 208525 | 208526 | 208525 | 355399 | 355399 | - |
| Schüco Si 82 | 208536 | 208535 | 208533 | 208532 | 208531 | 208530 | 208529 | 208526 | 208525 | 208525 | 208526 | 208525 | 355399 | 355399 | - |
| Thyssen AD | 208523 | 208522 | 208520 | 208519 | 208518 | 208517 | 208516 | 208513 | 208512 | 208512 | 208513 | 208512 | 355399 | 355399 | - |
| Thyssen Prestige | 208523 | 208522 | 208520 | 208519 | 208518 | 208517 | 208516 | 208513 | 208512 | 208512 | 208513 | 208512 | 355399 | 355399 | - |
| Trocal Innova A3 | 208499 | 208498 | 208494 | 208493 | 208492 | 208491 | 208490 | 208487 | 208486 | 208486 | 208487 | 208486 | 355399 | 355399 | - |
| Trocal Innova A5 | 208499 | 208498 | 208494 | 208493 | 208492 | 208491 | 208490 | 208487 | 208486 | 208486 | 208487 | 208486 | 355399 | 355399 | - |
| Trocal Innova Comfort | 208499 | 208498 | 208494 | 208493 | 208492 | 208491 | 208490 | 208487 | 208486 | 208486 | 208487 | 208486 | 355399 | 355399 | - |
| Trocal Innova M5 MD | 208605 | 208606 | - | - | - | - | - | - | - | - | - | - | - | - | - |
| Trocal Innova 2000 MD | 208607 | 208608 | - | - | - | - | - | - | - | - | - | - | - | - | - |
| Trocal 88+ MD | 208607 | 208608 | - | - | - | - | - | - | - | - | - | - | - | - | - |
| Veka Topline m. Beschlagsnut 13V | 208586 | 208585 | 208583 | 208582 | 208581 | 208580 | 208579 | 208576 | 208575 | 208575 | 208576 | 208575 | 355399 | 355399 | - |

*Взломостойкая (усиленная стальная пластина в области запорного ригеля)



4.2 Запорные планки для ПВХ под замки Z-TS Modul PT-M

4.2.1 Дерево

4.2.1.1 Одиночные запорные планки

| | Ширина фальца | | | |
|---|----------------------|-----------------------|-----------------------|-----------------------|
| | 18 мм (Смещение 9мм) | 20 мм (Смещение 10мм) | 24 мм (Смещение 13мм) | 26 мм (Смещение 15мм) |
| Фалевая - ригельная запорная планка | | | | |
| 209909  Для фальцлюфта 4 мм, правая | 29776 | 29787 | 209907 | - |
| 210809  Для фальцлюфта 4 мм, левая | 29776 | 29787 | 209908 | - |
| 214455, 215683  Для фальцлюфта 12 мм, правая | 55987 | 29787 | 209809 | - |
| 203502  Для фальцлюфта 12 мм, левая | 55987 | 29787 | 209810 | - |
| Угловая фалевая - ригельная запор. пластина для систем электрон. открыв., фальцл. 4 мм, 25x32 мм, прав. | 203502 | 203502 | 360614 | - |
| Угловая фалевая - ригельная запор. пластина для систем электрон. открыв., фальцл. 4 мм, 25x32 мм, лев. | 203503 | 203503 | 360615 | - |
| Угловая фалевая - ригельная запор. пластина для систем электрон. открыв., фальцл. 4 мм, 24x8 мм, прав. | - | - | 214455 | - |
| Угловая фалевая - ригельная запор. пластина для систем электрон. открыв., фальцл. 4 мм, 24x8 мм, лев. | - | - | 214456 | - |
| Угловая фалевая - ригельная запор. пластина для систем электрон. открыв., фальцл. 4 мм, 26x8 мм, прав. | - | - | - | 215683 |
| Угловая фалевая - ригельная запор. пластина для систем электрон. открыв., фальцл. 4 мм, 26x8 мм, лев. | - | - | - | 215684 |
| Угловая фалевая - ригельная запор. пластина для систем электрон. открыв., фальцл. 4 мм, 26x8 мм, прав. | - | - | - | - |
| Угловая фалевая - ригельная запор. пластина для систем электрон. открыв., фальцл. 4 мм, 26x8 мм, лев. | - | - | - | - |
| Угловая фалевая - ригельная запор. пластина для систем электрон. открыв., фальцл. 12 мм, правая | 210809 | 210811 | 210016 | - |
| Угловая фалевая - ригельная запор. пластина для систем электрон. открыв., фальцл. 12 мм, левая | 210810 | 210812 | 210017 | - |
| Торцевая накладка для угловой фалевой - ригельной запорной пластины 24x8 мм, 12 мм фальцлюфт | - | - | 362920 | - |
| 209909  354358  209909, 215685  362920  | | | | |
| Запорная планка под крюк-штульпу | | | | |
| Для фальцлюфта 4 мм, правая | 207862 | 207861 | 209909 | - |
| Для фальцлюфта 12 мм, левая | 207862 | 207861 | 210779 | - |
| Угловая фалевая - ригельная запорная пластина, фальцлюфт 4 мм, 24x8 мм | - | - | 214459 | - |
| Угловая фалевая - ригельная запорная пластина, фальцлюфт 4 мм, 26x8 мм | - | - | - | 215685 |
| Торцевая накладка, 12 мм фальцлюфт | 43718 | 354358 | - | - |
| Торцев. накладка для углов. фалевой - ригельной запорн. пластины 24x8 мм, 12 мм фальцл | - | - | 362920 | - |
| Декоративная вставка | 358024 | 358024 | 358024 | - |

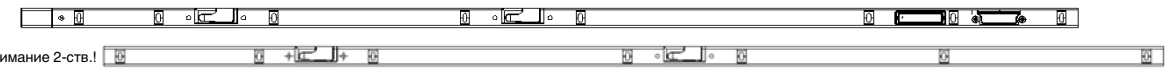
4.2.1.2 Шульпы запорных планок

| Шульпы запорных планок для дерева, ширина фальца 24 мм, смещение 13 мм, U-шульп 6/24/6 | |
|--|--------|
|  | |
| Шульп запорных планок для 2 крюков 2 штырей, правый, ширина фальца 24 мм, смещение 13 мм, U-шульп 6/24/6 | 214190 |
| Шульп запорных планок для 2 крюков 2 штырей, левый, ширина фальца 24 мм, смещение 13 мм, U-шульп 6/24/6 | 214191 |
|  <p>Внимание 2-ств.!</p> | |
| Шульп запорных планок для 4 i.S. цапф, правый, ширина фальца 24 мм, смещение 13 мм, U-шульп 6/24/6 | 102850 |
| Шульп запорных планок для 4 i.S. цапф, левый, ширина фальца 24 мм, смещение 13 мм, U-шульп 6/24/6 | 102851 |
|  <p>209909 362704 </p> | |
| Удлинитель для шульпа запорных планок для дерева, ширина фальца 24 мм, смещение 13 мм, U-шульп 6/24/6 | 102852 |
| Накладка для фиксации саморезом под углом | 362704 |

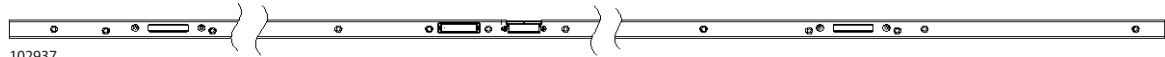
| Шульпы запорных планок для дерева, ширина фальца 28 мм, смещение 13 мм, U-шульп 8/28/8 | |
|---|--------|
|  <p>102937</p> | |
| Шульп запорн. планок со съёмными наклад. для 2 крюков и 2 штырей, правый, фальцл. 12 мм, смещ. 13 мм, U-8/28/8 | 102937 |
| Шульп запорн. планок со съёмными наклад. для 2 крюков и 2 штырей, левый, фальц. 12 мм, смещ. 13 мм, U-8/28/8 | 102938 |
| Шульп запорн. планок со съёмными наклад. для 4 крюков и 4 штырей, правый, фальцл.12 мм, смещ. 13 мм, U-8/28/8 | 102939 |
| Шульп запорн. планок со съёмными наклад. для 4 крюков и 4 штырей, левый, фальцл. 12 мм, смещ. 13 мм, U-8/28/8 | 102940 |
| Шульп запорн. планок со съёмными накладк. для 2 крюков и 2 i.S. цапф, правый, фальцл.12 мм, смещ. 13 мм, U-8/28/8 | 102981 |
| Шульп запорн. планок со съёмными наклад. для 2 крюков и 2 i.S. цапф, левый, фальцл. 12 мм, смещ. 13 мм, U-8/28/8 | 102982 |

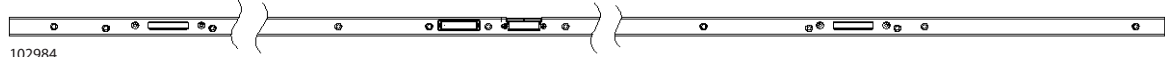

| Шульпы запорных планок для дерева, ширина фальца 28 мм, смещение 13 мм, U-шульп 8/28/12 | |
|--|--------|
|  <p>102984</p> | |
| Шульп запорн. планок со съёмными наклад. для 2 крюков и 2 штырей, правый, фальцл. 12 мм, смещ. 13 мм, U-8/28/12 | 102984 |
| Шульп запорн. планок со съёмными наклад. для 2 крюков и 2 штырей, левый, фальцл. 12 мм, смещ. 13 мм, U-8/28/12 | 102985 |
| Шульп запорню планок со съёмными накладю для 4 крюков и 4 штырей, правый, фальцлю 12 мм, смещю 13 мм, U-8/28/8 | 102986 |
| Шульп запорн. планок со съёмными наклад. для 4 крюков и 4 штырей, левый, фальцл. 12 мм, смещ. 13 мм, U-8/28/12 | 102987 |
| Шульп запорн. планок со съёмными наклад. для 2 крюков и 2 i.S. цапф, правый, фальцл. 12 мм, смещ. 13 мм, U-8/28/12 | 102988 |
| Шульп запорн. планок со съёмными наклад. для 2 крюков и 2 i.S. цапф, левый, фальцл. 12 мм, смещ. 13 мм, U-8/28/12 | 102989 |

4.2.2 ПВХ

| Профили | Шульпа для 2 запорных планок под штыри-крюки, правый | Шульпа для 2 запорных планок под штыри-крюки, левый | Декоративная вставка, крюки-штыри |
|------------------------------|--|---|-----------------------------------|
| Alphacan MD | 213986 | 213987 | - |
| Aluplast 2000 | 211630 | 211631 | 358027 |
| Aluplast 4000 | 211632 | 211633 | 358027 |
| Aluplast 5000 | 211632 | 211633 | 358027 |
| Aluplast 6000 | 211632 | 211633 | 358027 |
| Beschlagsnut gegenüber | 211634 | 211635 | 358027 |
| Brüggmann AD | 211636 | 211637 | 358027 |
| Deceuninck Zendow | 208473 | 208472 | 358027 |
| Kömmeling Eurofutur | 207832 | 207833 | 358027 |
| Kömmeling Eurofutur MD | 207832 | 207833 | 358027 |
| Kömmeling Gold 70 | 207832 | 207833 | 358027 |
| Kömmeling Gold 70 - AS | 207832 | 207833 | 358027 |
| Kömmeling Eurofutur AD | 211638 | 211639 | 358027 |
| Kömmeling Eurofutur 35 | 211638 | 211639 | 358027 |
| Kömmeling Eurofutur | 211638 | 211639 | 358027 |
| Kömmeling 88+ MD | 213933 | 213934 | - |
| Rehau S 730 | 208599 | 208600 | 358027 |
| Salamander 2D | 208462 | 208463 | 358027 |
| Salamander 3D | 208462 | 208463 | 358027 |
| Schüco CT 70 - AS | 211630 | 211631 | 358027 |
| Schüco S 182 | 211630 | 211631 | 358027 |
| Thyssen AD | 208464 | 208465 | 358027 |
| Thyssen Prestige | 208464 | 208465 | 358027 |
| Trocal Innovova A3 | 208466 | 208467 | 358027 |
| Trocal Innovova A5 | 208466 | 208467 | 358027 |
| Trocal Innovova Comfort | 208466 | 208467 | 358027 |
| Trocal Innovova M5 MD | 213957 | 213958 | - |
| Trocal Innovova 2000 MD | 213945 | 213946 | - |
| Trocal 88+ MD | 213945 | 213946 | - |
| Veka Topline m. Beschlagsnut | 211636 | 211637 | 358027 |
| Veka Topline o. Beschlagsnut | 215348 | 215349 | 358027 |

| Профили | Запорная планка под крюк-штырь, ЗА | Декоративная вставка, крюки-штыри | Ответная планка ограничителя открывания двери, левая | Ответная планка ограничителя открывания двери, правая |
|------------------------------|------------------------------------|-----------------------------------|--|---|
| Alphacan Class | 211547 | 358027 | - | - |
| Aluplast 2000 | 211557 | 358027 | - | - |
| Aluplast 4000 | 211543 | 358027 | - | - |
| Aluplast 5000 | 211543 | 358027 | - | - |
| Beschlagsnut gegenüber | 211544 | 358027 | - | - |
| Brüggmann AD | 211545 | 358027 | 214368 | - |
| Brüggmann AD 20mm Vers. | 211546 | 358027 | - | - |
| Deceuninck 800 21mm Vers. | 211548 | 358027 | - | - |
| Deceuninck Zendow | 211549 | 358027 | - | - |
| Dimex Komfort | 211543 | 358027 | - | - |
| Duraliflex X 3500 | - | - | - | - |
| Gealan S 7000 | 211550 | 358027 | 214370 | - |
| Gealan S 8000 | 211550 | 358027 | 214370 | - |
| Gealan S 730 | 211551 | 358027 | 214374 | - |
| Greiner Intertec | 211541 | 358027 | - | - |
| KBE System 70 AD | 211551 | 358027 | 215433 | - |
| Kömmeling Eurofutur 35 | 211552 | 358027 | 214378 | - |
| Kömmeling Eurofutur | 211552 | 358027 | 214378 | - |
| Kömmeling Eurofutur MD | 211552 | 358027 | 214378 | - |
| Kömmeling Gold 70 | 211551 | 358027 | 215433 | - |
| Kömmeling Gold 70 - AS | 211553 | 358027 | 214374 | - |
| Rehau S 730 | - | - | - | - |
| Rehau S 730 New | - | - | - | - |
| Rehau Tritec | - | - | - | - |
| Salamander 2D | 211554 | 358027 | 214372 | - |
| Salamander 3D | 211554 | 358027 | 214372 | - |
| Schüco Corona AS | 211543 | 358027 | - | - |
| Schüco CT 70 - AS | 211557 | 358027 | - | - |
| Schüco CT 70 - MD | 211557 | 358027 | - | - |
| Schüco S 182 | 209095 | 358027 | - | - |
| Thyssen AD | 209180 | 358027 | - | - |
| Thyssen Prestige | 209179 | 358027 | - | - |
| Trocal Innovova A3 | 209184 | 358027 | 214376 | - |
| Trocal Innovova A5 | 209184 | 358027 | 214376 | - |
| Trocal Innovova Comfort | 209184 | 358027 | - | - |
| Veka Softline | 209189 | 358027 | - | - |
| Veka Topline | 211545 | 358027 | 214368 | - |
| VEKA Topline o. Beschlagsnut | 212461 | - | - | - |
| Wymar/Profex 2500 | 209191 | 358027 | - | - |
| Wymar/Profex 3000 | 209197 | 358027 | - | - |
| Wymar/Profex 3000 aussendr. | 209197 | 358027 | - | - |

4.2.3 Алюминиевый профиль

| Шульпы запорных планок из алюминия толщиной 3 мм | |
|---|--|
| Подходит к существующим алюминиевым профильным системам Heroal, Sapa, Alcoa, Wicona, Alumil, Schüco, Feal и др. | |
|  214407 |  214409 |
| Фалевые-ригельные запорные планки, правые | 214407 |
| Фалевые-ригельные запорные планки, левые | 214408 |
| Запорная планка под крюк-штырь | 214409 |
|  214466 | |
| Шульп запорных планок с вставкой под 2 мультифункциональные защёлки и 2 штыря, правый | 214466 |
| Шульп запорных планок с вставкой под 2 мультифункциональные защёлки и 2 штыря, левый | 214467 |
| Шульп запорных планок с вставкой под 2 мультифункциональные защёлки и 2 штыря, K+605, правый | 215227 |
| Шульп запорных планок с вставкой под 2 мультифункциональные защёлки и 2 штыря, K+605, левый | 215228 |
| Шульп запорных планок с вставкой под 2 мультифункциональные защёлки и 2 штыря, K+980, правый | 215229 |
| Шульп запорных планок с вставкой под 2 мультифункциональные защёлки и 2 штыря, K+980, левый | 215230 |

4.3 Запорные планки для ПВХ под замки Z-TF PT

4.3.1 Дерево

4.3.1.1 Одиночные запорные планки



| Фалевые-ригельные запорные планки | Ширина фальца | | |
|--|---------------------|----------------------|----------------------|
| | 18мм (Смещение 9мм) | 20мм (Смещение 10мм) | 24мм (Смещение 13мм) |
| для фальцлюфта 4 мм, правые | 29776 | 29787 | 209907 |
| для фальцлюфта 4 мм, левые | 29776 | 29787 | 209908 |
| для фальцлюфта 12 мм, правая | 55987 | 29787 | 209809 |
| для фальцлюфта 12 мм, левая | 55987 | 29787 | 209810 |
| Угловая фалевая - ригельная запорн. пластина для систем электрон. открывания, фальцл. 4 мм, 25x32 мм, правая | 203502 | 203502 | 360614 |
| Угловая фалевая - ригельная запорн. пластина для систем электрон. открывания, фальцл. 4 мм, 25x32 мм, левая | 203503 | 203503 | 360615 |
| Угловая фалевая - ригельная запорн. пластина для систем электрон. открывания, фальцл. 4 мм, 24x8мм, правая | - | - | 214455 |
| Угловая фалевая - ригельная запорн. пластина для систем электрон. открывания, фальцл. 4 мм, 24x8 мм, левая | - | - | 214456 |
| Угловая фалевая - ригельная запорн. пластина для систем электрон. открывания, фальцл. 4 мм, правая | 210809 | 210811 | 210016 |
| Угловая фалевая - ригельная запорн. пластина для систем электрон. открывания, фальцл. 12 мм, левая | 210810 | 210812 | 210017 |
| Торцевая накладка для угловой фалевой - ригельной запорной пластины, 12 мм фальцлюфт | - | - | 362920 |



| Фалевая запорная планка для мультифункциональной защёлки | Ширина фальца | | |
|---|---------------------|----------------------|----------------------|
| | 18мм (Смещение 9мм) | 20мм (Смещение 10мм) | 24мм (Смещение 13мм) |
| для фальцлюфта 4 мм | 210501 | 210502 | 211597 |
| для фальцлюфта 12 мм | 210501 | 210502 | 211598 |
| Угловая фалевая - ригельная запорн. пластина под фалевую защёлку - систем электрон. открыв., фальцл. 4 мм, 25x32 мм | 362003 | 362002 | - |
| Угловая фалевая - ригельная запорн. пластина с фалевой вставкой под фалевую защёлку, фальцл. 4 мм, 25x32 мм | 214527 | 214527 | - |
| Угловая фалевая - ригельная запорн. пластина под фалевую защёлку - систем электрон. открыв., ф. 12 мм, 8/18/32, U-8/20/32 | 213325 | 213326 | - |
| Угловая фалевая - ригельная запорн. пластина с фалевой вставкой под фалевую защёлку, фальцл. 12 мм, U-8/18/32, U-8/20/32 | 214504 | 214505 | - |
| Угловая фалевая - ригельная запорн. пластина под фалевую защёлку, фальцлюфт 4мм, 24x8 мм | - | - | 214458 |
| Торцевая накладка, 12 мм фальцлюфт | 360074 | 354358 | - |
| Торцевая накладка для угловой фалевой - ригельной запорной пластины 24x8 мм, 12 мм фальцлюфт | - | - | 362920 |







| Запорная планка под фалевую защёлку и штырь | Ширина фальца | | |
|--|---------------------|----------------------|----------------------|
| | 18мм (Смещение 9мм) | 20мм (Смещение 10мм) | 24мм (Смещение 13мм) |
| Угловая фалевая - ригельная запорн. пластина под фалевую защёлку и штырь - систем электрон. открыв., ф. 4 мм, 25x32 мм | 363322 | 363322 | - |
| Угловая фалевая - ригельная запорн. пластина с фалевой вставкой под фалевую защёлку и штырь, ф. 4 мм, 25x32 мм | 214968 | 214968 | - |
| Угловая фалевая - ригельная запорн. пл. под фалевую защёлку и штырь - систем электрон. открыв., ф. 12 мм, U-8/18/32, 8/20/32 | 214965 | 214966 | - |
| Угловая фалевая - ригельная запорная пластина под фалевую защёлку и штырь, фальцлюфт 4 мм, 24x8 мм | - | - | 214457 |
| Торцевая накладка для угловой фалевой - ригельной запорной пластины 24x8 мм, 12 мм фальцлюфт | - | - | 362920 |



| Взломостойкая запорная планка i.S. | Ширина фальца | | |
|--------------------------------------|---------------------|----------------------|----------------------|
| | 18мм (Смещение 9мм) | 20мм (Смещение 10мм) | 24мм (Смещение 13мм) |
| для фальцлюфта 4 мм, правые | 96565 | 96845 | 357673 |
| для фальцлюфта 4 мм, левые | 96566 | 96846 | 357674 |
| для фальцлюфта 12 мм, правая и левая | 96860 | 96561 | 96934 |

4.3.1.2 Шульпы запорных планок

| U-шульпы запорных планок, дерево, фальц 24 мм, смещение 13 мм, U-6/24/6 | |
|---|--------|
|  <p>Внимание 2-ств.!</p> | |
| Шульпы зап. планок с вставкой под 2 мультифункцион. защёлки и 2 i.S. планки, правый, K+500, ширина фальца 24 мм, смещение 13 мм, U-6/24/6 | 102846 |
| Шульпы зап. планок с вставкой под 2 мультифункцион. защёлки и 2 i.S. планки, левый, K+500, ширина фальца 24 мм, смещение 13 мм, U-6/24/6 | 102847 |
| Шульпы зап. планок с вставкой под 2 мультифункцион. защёлки и 2 i.S. планки, правый, ширина фальца 24 мм, смещение 13 мм, U-6/24/6 | 102842 |
| Шульпы зап. планок с вставкой под 2 мультифункцион. защёлки и 2 i.S. планки, левый, ширина фальца 24 мм, смещение 13 мм, U-6/24/6 | 102843 |
| Шульпы зап. планок с вставкой под 2 мультифункцион. защёлки и 3 i.S. планки, правый, ширина фальца 24 мм, смещение 13 мм, U-6/24/6 | 102844 |
| Шульпы зап. планок с вставкой под 2 мультифункцион. защёлки и 3 i.S. планки, левый, ширина фальца 24 мм, смещение 13 мм, U-6/24/6 | 102845 |
|  <p>215907</p> | |
| Шульпы зап. планок с вставкой под 2 мультифункцион. защёлки и 2 штыря, правый, ширина фальца 24 мм, смещение 13 мм, U-6/24/6 | 215907 |
| Шульпы зап. планок с вставкой под 2 мультифункцион. защёлки и 2 штыря, левый, ширина фальца 24 мм, смещение 13 мм, U-6/24/6 | 215908 |
| Шульпы зап. планок с вставкой под 2 мультифункцион. защёлки и 2 штыря, правый, K+980 ширина фальца 24 мм, смещение 13 мм, U-6/24/6 | 215909 |
| Шульпы зап. планок с вставкой под 2 мультифункцион. защёлки и 2 штыря, левый, K+980 ширина фальца 24 мм, смещение 13 мм, U-6/24/6 | 215910 |
| Шульпы запорн. планок с вставкой под 2 мультифункцион. защёлки и 2 штыря, правый, K+605 ширина фальца 24 мм, смещение 13 мм, U-6/24/6 | 215911 |
| Шульпы зап. планок с вставкой под 2 мультифункцион. защёлки и 2 штыря, левый, K+605 ширина фальца 24 мм, смещение 13 мм, U-6/24/6 | 215912 |
|  <p>209909</p> | |
| 362704  | |
| Удлинитель для шульпы зап. планок для дерева, ширина фальца 24 мм, смещение 13 мм, U-6/24/6 | 102852 |
| Накладна для фиксации саморезом под углом | 362704 |

Шульпы заборных планок для дерева, ширина фальца 28 мм, смещение 13 мм, U-шульпы 8/28/8

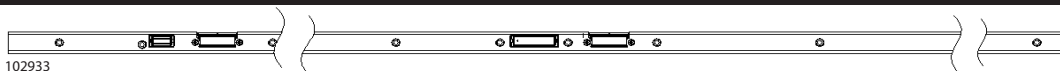

| | |
|--|--------|
| Шульпы заборных планок со съёмными накладками для 2 крюков и 2 штырей, правый, фальцлюфт 12 мм, смещение 13 мм, U-8/28/8 | 102933 |
| Шульпы заборных планок со съёмными накладками для 2 крюков и 2 штырей, левый, фальцлюфт 12 мм, смещение 13 мм, U-8/28/8 | 102934 |
| Шульпы забор. планок со съёмными накладками для 2 крюков и 2 штырей, правый, K+980, фальц. 12 мм, смещение 13 мм, U-8/28/8 | 102935 |
| Шульпы забор. планок со съёмными накладками для 2 крюков и 2 штырей, левый, K+980, фальц. 12 мм, смещение 13 мм, U-8/28/8 | 102936 |
| Шульпы забор. планок со съёмными накладками для 2 крюков и 2 i.S. цапф, правый, фальц. 12 мм, смещение 13 мм, U-8/28/8 | 102964 |
| Шульпы забор. планок со съёмными накладками для 2 крюков и 2 i.S. цапф, левый, фальц. 12 мм, смещение 13 мм, U-8/28/8 | 102965 |
| Шульпы забор. планок со съёмными накладками для 2 крюков и 3 i.S. цапф, правый, фальц. 12 мм, смещение 13 мм, U-8/28/8 | 102966 |
| Шульпы забор. планок со съёмными накладками для 2 крюков и 3 i.S. цапф, левый, фальц. 12 мм, смещение 13 мм, U-8/28/8 | 102967 |

Шульпы заборных планок для дерева, ширина фальца 28 мм, смещение 13 мм, U-8/28/12





| | |
|---|--------|
| Шульпы забор. планок со съёмными накладками для 2 крюков и 2 штырей, правый, фальц. 12 мм, смещение 13 мм, U-8/28/12 | 102990 |
| Шульпы забор. планок со съёмными накладками для 2 крюков и 2 штырей, левый, фальц. 12 мм, смещение 13 мм, U-8/28/12 | 102991 |
| Шульпы забор. планок со съёмными накладками для 2 крюков и 2 штырей, правый, K+980, фальц. 12 мм, смещение 13 мм, U-8/28/12 | 102992 |
| Шульпы забор. планок со съёмными накладками для 2 крюков и 2 штырей, левый, K+980, фальц. 12 мм, смещение 13 мм, U-8/28/12 | 102993 |
| Шульпы забор. планок со съёмными накладками для 2 крюков и 2 i.S. цапф, правый, фальц. 12 мм, смещение 13 мм, U-8/28/12 | 102994 |
| Шульпы забор. планок со съёмными накладками для 2 крюков и 2 i.S. цапф, левый, фальц. 12 мм, смещение 13 мм, U-8/28/12 | 102995 |
| Шульпы забор. планок со съёмными накладками для 2 крюков и 3 i.S. цапф, правый, фальц. 12 мм, смещение 13 мм, U-8/28/12 | 102996 |
| Шульпы забор. планок со съёмными накладками для 2 крюков и 3 i.S. цапф, левый, фальц. 12 мм, смещение 13 мм, U-8/28/12 | 102997 |

4.3.2.2 Штульпы запорных планок

| Профиль | Штульпы зап. планок замка ZTF-2 мультифункционал. фалевые защёлки и 2 I.S. цапфы, правый | | Штульпы зап. планок замка ZTF-2 мультифункционал. фалевые защёлки и 2 I.S. цапфы, левый | | Штульпы зап. планок замка ZTF-2 мультифункционал. фалевые защёлки и 2 I.S. цапфы, Н+500, левый | | Штульпы зап. планок замка ZTF-2 мультифункционал. фалевые защёлки и 3 I.S. цапфы, Н+1000, правый | | Штульпы зап. планок замка ZTF-2 мультифункционал. фалевые защёлки и 3 I.S. цапфы, Н+1000, левый | | Штульпы зап. планок замка ZTF-2 мультифункционал. фалевые защёлки и 4 I.S. цапфы, левый | | Штульпы зап. планок замка ZTF-2 мультифункционал. фалевые защёлки и 4 I.S. цапфы, правый | |
|------------------------------|--|--------|---|--------|--|--------|--|--------|---|--------|---|---|--|--|
| | 210911 | 210912 | - | - | - | - | - | - | - | - | - | - | - | |
| Alphacan Class | 210911 | 210912 | - | - | - | - | - | - | - | - | - | - | - | |
| Alphacan MD | 213976 | 213977 | 213980 | 213981 | 213978 | 213979 | 213982 | 213983 | - | - | - | - | - | |
| Aluplast 2000 | 210726 | 210727 | 213700 | 213701 | 213702 | 213703 | 213704 | 213705 | 213706 | 213707 | - | - | - | |
| Aluplast 4000 | 210728 | 210729 | 212806 | 212807 | 212808 | 212809 | 212810 | 212811 | 212812 | 212813 | - | - | - | |
| Aluplast 5000 | 210728 | 210729 | 212806 | 212807 | 212808 | 212809 | 212810 | 212811 | 212812 | 212813 | - | - | - | |
| Aluplast 6000 | 210728 | 210729 | 212806 | 212807 | 212808 | 212809 | 212810 | 212811 | 212812 | 212813 | - | - | - | |
| Beschlagsnut gegenüber | 210730 | 210731 | 213385 | 213386 | 213387 | 213388 | 213389 | 213390 | 213391 | 213392 | - | - | - | |
| Brügmann AD | 210732 | 210733 | 213685 | 213686 | 213687 | 213688 | 213629 | 213630 | 213689 | 213690 | - | - | - | |
| Deceuninck Zendow | 210913 | 210914 | 213400 | 213401 | 213402 | 213403 | 213404 | 213405 | 213406 | 213407 | - | - | - | |
| Dimex Komfort | 210728 | 210729 | 212806 | 212807 | 212808 | 212809 | 212810 | 212811 | 212812 | 212813 | - | - | - | |
| Gealan S 3000 | 207831 | 207830 | 213377 | 213378 | 213379 | 213380 | 213381 | 213382 | 213383 | 213384 | - | - | - | |
| Gealan S 7000 | 207831 | 207830 | 213377 | 213378 | 213379 | 213380 | 213381 | 213382 | 213383 | 213384 | - | - | - | |
| Gealan S 8000 | 207831 | 207830 | 213377 | 213378 | 213379 | 213380 | 213381 | 213382 | 213383 | 213384 | - | - | - | |
| KBE System 70 AD | 210744 | 210745 | 213839 | 213840 | 213841 | 213842 | 213843 | 213844 | 213845 | 213846 | - | - | - | |
| Kömmerling Avantgarde | 210734 | 210735 | 213708 | 213709 | 213710 | 213711 | 213712 | 213713 | 213714 | 213715 | - | - | - | |
| Kömmerling Eurofutur AD | 210734 | 210735 | 213708 | 213709 | 213710 | 213711 | 213712 | 213713 | 213714 | 213715 | - | - | - | |
| Kömmerling Eurodur 3S | 210734 | 210735 | 213708 | 213709 | 213710 | 213711 | 213712 | 213713 | 213714 | 213715 | - | - | - | |
| Kömmerling Eurofutur MD | 210734 | 210735 | 213708 | 213709 | 213710 | 213711 | 213712 | 213713 | 213714 | 213715 | - | - | - | |
| Kömmerling Gold 70 | 210744 | 210745 | - | - | - | - | - | - | - | - | - | - | - | |
| Kömmerling 88+ | 213923 | 213924 | 213927 | 213928 | 213925 | 213926 | 213931 | 213932 | - | - | - | - | - | |
| Rehau S 730 | 210736 | 210737 | 213716 | 213717 | 213718 | 213719 | 213720 | 213721 | 213722 | 213723 | - | - | - | |
| Salamander 2D | 210738 | 210739 | 213724 | 213725 | 213726 | 213727 | 213728 | 213729 | 213730 | 213731 | - | - | - | |
| Salamander 3D | 210738 | 210739 | 213724 | 213725 | 213726 | 213727 | 213728 | 213729 | 213730 | 213731 | - | - | - | |
| Schüco CT 70 - AS | 210726 | 210727 | 213700 | 213701 | 213702 | 213703 | 213704 | 213705 | 213706 | 213707 | - | - | - | |
| Schüco Si 82 | 210726 | 210727 | 213700 | 213701 | 213702 | 213703 | 213704 | 213705 | 213706 | 213707 | - | - | - | |
| Thyssen AD | 210740 | 210741 | 213732 | 213733 | 213734 | 213735 | 213736 | 213737 | 213738 | 213739 | - | - | - | |
| Thyssen Prestige | 210740 | 210741 | 213732 | 213733 | 213734 | 213735 | 213736 | 213737 | 213738 | 213739 | - | - | - | |
| Trocal Innonova A3 | 210742 | 210743 | 213740 | 213741 | 213742 | 213743 | 213744 | 213745 | 213746 | 213747 | - | - | - | |
| Trocal Innonova A5 | 210742 | 210743 | 213740 | 213741 | 213742 | 213743 | 213744 | 213745 | 213746 | 213747 | - | - | - | |
| Trocal Innonova Confort | 210742 | 210743 | 213740 | 213741 | 213742 | 213743 | 213744 | 213745 | 213746 | 213747 | - | - | - | |
| Trocal Innonova M5 | 213949 | 213950 | 213953 | 213954 | 213951 | 213952 | 213955 | 213956 | - | - | - | - | - | |
| Trocal Innonova 2000 | 213937 | 213938 | 213941 | 213942 | 213939 | 213940 | 213943 | 213944 | - | - | - | - | - | |
| Trocal 88+ | 213937 | 213938 | 213941 | 213942 | 213939 | 213940 | 213943 | 213944 | - | - | - | - | - | |
| Veka Topline m. Beschlagsnut | 210732 | 210733 | 213685 | 213686 | 213687 | 213688 | 213629 | 213630 | 213689 | 213690 | - | - | - | |
| Wymar Profex 2500 | 210915 | 210916 | - | - | - | - | - | - | - | - | - | - | - | |
| Wymar Profex 3000 | 210917 | 210918 | - | - | - | - | - | - | - | - | - | - | - | |

4.3.3 Алюминиевый профиль

| Шульпы запорных планок из алюминия толщиной 3 мм | |
|---|--|
| Подходит к существующим алюминиевым профильным системам Heroal, Sapa, Alcoa, Wicona, Alumil, Schüco, Feal и др. | |
|  214407 |  214409 |
| Фалевая-ригельная запорная планка, взломостойкая правая | 214407 |
| Фалевая-ригельная запорная планка, взломостойкая левая | 214408 |
| Запорная планка под крюк-штырь | 214409 |
|  214466 | |
| Шульп запорных планок под крюки-штыри, правый | 214466 |
| Шульп запорных планок под крюки-штыри, левый | 214467 |
| Шульп запорных планок под крюки-штыри, К+605 , правый | 215227 |
| Шульп запорных планок под крюки-штыри, К+605 , левый | 215228 |
| Шульп запорных планок под крюки-штыри, К+980 , правый | 215229 |
| Шульп запорных планок под крюки-штыри, К+980 , левый | 215230 |

**MACO
PROTECT**



Запорные планки и штульпы запорных планок



5 Концевые запоры для дверных замков





| | | |
|-----|---|-----|
| 5.1 | Концевые запоры _____ | 102 |
| 5.2 | Концевые запоры обратного направления _____ | 105 |

5 Концевые запоры для дверных замков





5.1 Концевые запоры

5.1.1 Концевой запор с выдвижным стержнем и угловым креплением







| 5.1.1.1 Концевой запор с выдвижным стержнем и угловым креплением Штульп F-16 |  | L |  |  |  |  | № | € |
|--|---|-----|---|---|---|---|-------|---|
| . | 1.900 - 2.100 | 300 | 16 | 255 | 0 | 10 | 58331 | |
| | | | | | 1 | 10 | 58329 | |
| . | 2.100 - 2.300 | 500 | 16 | 255 | 0 | 10 | 59405 | |
| | | | | | 1 | 10 | 58330 | |







| 5.1.1.2 Концевой запор с выдвижным стержнем и угловым креплением Штульп F-20 |  | L |  |  |  |  | № | € |
|--|--|-----|--|--|--|--|--------|---|
| . | 1.900 - 2.100 | 300 | 20 | 255 | 0 | 10 | 201162 | |
| | | | | | 1 | 10 | 201160 | |
| . | 2.100 - 2.300 | 500 | 20 | 255 | 0 | 10 | 201163 | |
| | | | | | 1 | 10 | 201161 | |









| 5.1.1.3 Концевой запор с выдвижным стержнем и угловым креплением Штульп F-24 |  | L |  |  |  |  | № | € |
|--|---|-----|---|---|---|---|--------|---|
| . | 1.900 - 2.100 | 300 | 24 | 255 | 0 | 10 | 101493 | |
| | | | | | 1 | 10 | 101492 | |

5.1.2 Концевой запор с выдвижным стержнем





58107 

| 5.1.2.1 Концевой запор с выдвижным стержнем Штульп F-16 |  | L |  |  |  |  | № | € |
|---|---|-----|---|---|---|---|-------|---|
| | 1.900 - 2.100 | 300 | 16 | 255 | 1 | 10 | 58107 | |
| | 2.100 - 2.300 | 500 | 16 | 255 | 1 | 10 | 55992 | |
| | 2.185 - 2.385 | 585 | 16 | 540 | 1 | 10 | 58458 | |
| | 2.385 - 2.585 | 785 | 16 | 540 | 1 | 10 | 58333 | |





101483 

| 5.1.2.2 Концевой запор с выдвижным стержнем Штульп F-20 |  | L |  |  |  |  | № | € |
|---|---|-----|---|---|---|---|--------|---|
| | 1.900 - 2.100 | 300 | 20 | 255 | 1 | 10 | 101483 | |

101500 





| 5.1.2.3 Концевой запор с выдвижным стержнем Штульп F-24 |  | L |  |  |  |  | № | € |
|---|---|-----|---|---|---|---|--------|---|
| | 1.900 - 2.100 | 300 | 24 | 255 | 1 | 10 | 101500 | |

215154 





| 5.1.2.4 Концевой запор с выдвижным стержнем Штульп F-24/16 |  | L |  |  |  |  | № | € |
|--|---|-----|---|---|---|---|--------|---|
| | 1.900 - 2.100 | 300 | 24 | 255 | 1 | 5 | 215154 | |

5.1.3 Концевой запор без выдвижного стержня





57824 

| 5.1.3.1 Концевой запор без выдвижного стержня Штульп F-16 |  | L |  |  |  |  | № | € |
|---|---|----|---|---|---|---|---|---|
| 1.900 - 2.100 | 300 | 16 | 255 | 1 | 10 | 57824 | | |
| 2.100 - 2.300 | 500 | 16 | 255 | 1 | 10 | 55993 | | |
| 2.185 - 2.385 | 585 | 16 | 540 | 1 | 10 | 57825 | | |
| 2.300 - 2.500 | 700 | 16 | 255 | 1 | 10 | 57826 | | |
| 2.385 - 2.585 | 785 | 16 | 540 | 1 | 10 | 57827 | | |





11243 

| 5.1.3.2 Концевой запор без выдвижного стержня Штульп F-20 |  | L |  |  |  |  | № | € |
|---|---|----|---|---|---|---|---|---|
| 1.900 - 2.100 | 300 | 20 | 255 | 1 | 10 | 11243 | | |
| 2.100 - 2.300 | 500 | 20 | 255 | 1 | 10 | 11244 | | |
| 2.185 - 2.385 | 585 | 20 | 540 | 1 | 10 | 101489 | | |
| 2.300 - 2.500 | 700 | 20 | 255 | 1 | 10 | 101490 | | |
| 2.385 - 2.585 | 785 | 20 | 540 | 1 | 10 | 101491 | | |

101506 

| 5.1.3.3 Концевой запор без выдвижного стержня Штульп F-24 |  | L |  |  |  |  | № | € |
|---|---|----|---|---|---|---|---|---|
| 1.900 - 2.100 | 300 | 24 | 255 | 1 | 10 | 101506 | | |
| 2.100 - 2.300 | 500 | 24 | 255 | 1 | 10 | 101507 | | |
| 2.185 - 2.385 | 585 | 24 | 540 | 1 | 10 | 101508 | | |
| 2.300 - 2.500 | 700 | 24 | 255 | 1 | 10 | 101509 | | |
| 2.385 - 2.585 | 785 | 24 | 540 | 1 | 10 | 101510 | | |





215167 

| 5.1.3.4 Концевой запор без выдвижного стержня Штульп F-24/16 |  | L |  |  |  |  | № | € |
|--|---|----|---|---|---|---|---|---|
| 1.900 - 2.100 | 300 | 24 | 255 | 1 | 1 | 212767 | | |
| 2.100 - 2.300 | 500 | 24 | 255 | 1 | 5 | 215167 | | |
| 2.185 - 2.385 | 585 | 24 | 540 | 1 | 5 | 215172 | | |
| 2.300 - 2.500 | 700 | 24 | 255 | 1 | 5 | 215169 | | |
| 2.385 - 2.585 | 785 | 24 | 540 | 1 | 5 | 215175 | | |





5.2 Концевые запоры обратного направления

5.2.1 Концевой запор обратного направления с выдвижным стержнем и угловым креплением







| 5.2.1.1 Концевой запор обратного направления с выдвижным стержнем и угловым креплением Штульп F-16 |  | L |  |  |  |  | № | € |
|---|---|-----|---|---|---|---|--------|---|
| 1.900 - 2.100 | | 300 | 16 | 255 | 0 | 10 | 58335 | |
| | | | | | 1 | 10 | 58191 | |
| 2.100 - 2.300 | | 500 | 16 | 255 | 0 | 10 | 200982 | |
| | | | | | 1 | 10 | 200981 | |
| 2.185 - 2.385 | | 585 | 16 | 540 | 1 | 10 | 201184 | |
| 2.300 - 2.500 | | 700 | 16 | 255 | 1 | 10 | 201186 | |
| 2.385 - 2.585 | | 785 | 16 | 540 | 1 | 10 | 201185 | |







| 5.2.1.2 Концевой запор обратного направления с выдвижным стержнем и угловым креплением Штульп F-20 |  | L |  |  |  |  | № | € |
|---|---|-----|---|---|---|---|--------|---|
| 1.900 - 2.100 | | 300 | 20 | 255 | 0 | 10 | 101073 | |
| | | | | | 1 | 10 | 101072 | |
| 2.100 - 2.300 | | 500 | 20 | 255 | 1 | 10 | 101479 | |
| 2.185 - 2.385 | | 585 | 20 | 540 | 1 | 10 | 101480 | |
| 2.300 - 2.500 | | 700 | 20 | 255 | 1 | 10 | 101481 | |
| 2.385 - 2.585 | | 785 | 20 | 540 | 1 | 10 | 101482 | |







| 5.2.1.3 Концевой запор обратного направления с выдвижным стержнем и угловым креплением Штульп F-24 |  | L |  |  |  |  | № | € |
|---|---|-----|---|---|---|---|--------|---|
| 1.900 - 2.100 | | 300 | 24 | 255 | 0 | 10 | 101499 | |
| | | | | | 1 | 10 | 101494 | |
| 2.100 - 2.300 | | 500 | 24 | 255 | 1 | 10 | 101495 | |
| 2.185 - 2.385 | | 585 | 24 | 540 | 1 | 10 | 101496 | |
| 2.300 - 2.500 | | 700 | 24 | 255 | 1 | 10 | 101497 | |
| 2.385 - 2.585 | | 785 | 24 | 540 | 1 | 10 | 101498 | |

5.2.2 Концевой запор обратного направления с выдвижным стержнем







| 5.2.2.1 Концевой запор обратного направления с выдвижным стержнем Штульп F-16 |  | L |  |  |  |  | № | € |
|---|---|-----|---|---|---|---|--------|---|
| 1.900 - 2.100 | | 300 | 16 | 255 | 1 | 10 | 200983 | |
| 2.100 - 2.300 | | 500 | 16 | 255 | 1 | 10 | 200984 | |
| 2.185 - 2.385 | | 585 | 16 | 540 | 1 | 10 | 200985 | |
| 2.300 - 2.500 | | 700 | 16 | 255 | 1 | 10 | 200986 | |
| 2.385 - 2.585 | | 785 | 16 | 540 | 1 | 10 | 200987 | |





101484 

| 5.2.2.2 Концевой запор обратного направления с выдвижным стержнем Штульп F-20 |  | L |  |  |  |  | № | € |
|---|---|-----|---|---|---|---|--------|---|
| | 1.900 - 2.100 | 300 | 20 | 255 | 1 | 10 | 101484 | |
| | 2.100 - 2.300 | 500 | 20 | 255 | 1 | 10 | 101485 | |
| | 2.185 - 2.385 | 585 | 20 | 540 | 1 | 10 | 101486 | |
| | 2.300 - 2.500 | 700 | 20 | 255 | 1 | 10 | 101487 | |
| | 2.385 - 2.585 | 785 | 20 | 540 | 1 | 10 | 101488 | |

101501 

| 5.2.2.3 Концевой запор обратного направления с выдвижным стержнем Штульп F-24 |  | L |  |  |  |  | № | € |
|---|---|-----|---|---|---|---|--------|---|
| | 1.900 - 2.100 | 300 | 24 | 255 | 1 | 10 | 101501 | |
| | 2.100 - 2.300 | 500 | 24 | 255 | 1 | 10 | 101502 | |
| | 2.300 - 2.500 | 700 | 24 | 255 | 1 | 10 | 101504 | |
| | 2.385 - 2.585 | 785 | 24 | 540 | 1 | 10 | 101505 | |

215160 

| 5.2.2.4 Концевой запор обратного направления с выдвижным стержнем Штульп F-24/16 |  | L |  |  |  |  | № | € |
|--|---|-----|---|---|---|---|--------|---|
| | 1.900 - 2.100 | 300 | 24 | 255 | 1 | 5 | 215160 | |
| | 2.100 - 2.300 | 500 | 24 | 255 | 1 | 5 | 215164 | |
| | 2.185 - 2.385 | 585 | 24 | 540 | 1 | 5 | 215173 | |
| | 2.300 - 2.500 | 700 | 24 | 255 | 1 | 5 | 215170 | |
| | 2.385 - 2.585 | 785 | 24 | 540 | 1 | 5 | 215176 | |



6 Штульповые механизмы и дверные шпингалеты

| | | |
|-----|---------------------------|-----|
| 6.1 | Подбор фурнитуры _____ | 108 |
| 6.2 | Штульповой механизм _____ | 109 |
| 6.3 | Дверной шпингалет _____ | 110 |

6 Штульповые механизмы и дверные шпингалеты

6.1 Подбор фурнитуры

Штульповой механизм с концевыми запорами PROTECT

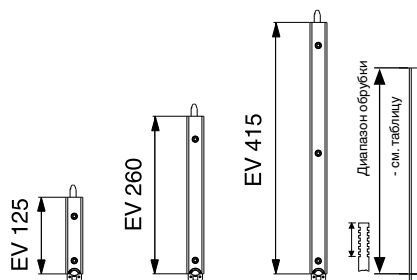

Концевые запоры для штульпового механизма

Определение длины штульпового механизма :

Длина штульпового механизма = Высота створки по фальцу (FFH) - длина концевого запора
Пример: 2100 мм (FFH) - 125 мм (длина концевого запора) = 1975 мм (длина штульпового механизма)

Важная информация:

Обрубка и монтаж концевых запоров осуществляется в закрытом положении штульпового механизма. Место обрубki должно быть тщательно зачищено и защищено от коррозии.

Диапазоны применения

| Вид запирания | ШМ | | КЗ 125 | КЗ 260 | КЗ 415 |
|--------------------|-------|-----|--------|--------|--------|
| | Длина | | FFH | FFH | FFH |
| 2 НОВО | 2255 | 340 | 2175 | 2515 | 2670 |
| 2 MF+2 i.S. | | | 2040 | 2175 | 2330 |
| 2 MF-BO | 2400 | 185 | 2475 | 2660 | 2815 |
| 2 MF+2 i.S. K+1030 | | | 2340 | 2475 | 2630 |

2НО-ВО = 2 крюка - 2 штыря
 2MF+2 i.S.= 2 мультифункциональных фалевых защёлки + 2 i.S. цапфы
 2MF-BO = 2 мультифункциональных фалевых защёлки + 2 штыря
 2MF+2i.S.K+1030= 2 мультифункциональных фалевых защёлки + 2 i.S. цапфы, K+1030
 2MF-BO K+980 = 2 мультифункциональных фалевых защёлки + 2 i.S. цапфы, K+980

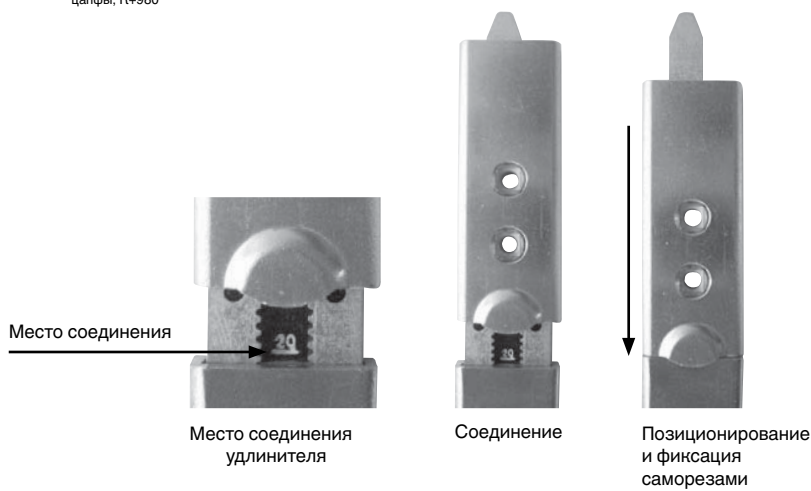



6.2 Штульповой механизм

| Штульповые механизмы и концевые запоры Дерево, смещение 13 мм, U-штульп 8x28x8 мм | 2НО-ВО | | 2MF+2I.S. | | 2MF+3I.S. K+1030 | | 2MF-BO | | 2MF-BO K+980 | |
|--|--------|--------|-----------|--------|------------------|--------|--------|--------|--------------|--------|
| | правые | левые | правые | левые | правые | левые | правые | левые | правые | левые |
| Штульповой механизм для дерева, фальцподот 12 мм, U-штульп 8x28x8 | 212409 | 212410 | 212413 | 212414 | 212415 | 212416 | 214208 | 214209 | 214210 | 214211 |
| Концевые запоры 125 мм, U-штульп 8x28x8, FFH 2040-2175 мм | 215858 | 215859 | 215858 | 215859 | - | - | 215858 | 215859 | - | - |
| Концевые запоры 260 мм, U-штульп 8x28x8, FFH 2175-2515 мм | 212419 | 212420 | 212419 | 212420 | - | - | 212419 | 212420 | - | - |
| Концевые запоры 415 мм, U-штульп 8x28x8, FFH 2330-2670 мм | 212421 | 212422 | 212421 | 212422 | - | - | 212421 | 212422 | - | - |
| Концевые запоры 125 мм, U-штульп 8x28x8, FFH 2340-2475 мм | - | - | - | - | 215858 | 215859 | - | - | 215858 | 215859 |
| Концевые запоры 260 мм, U-штульп 8x28x8, FFH 2475-2660 мм | - | - | - | - | 212419 | 212420 | - | - | 212419 | 212420 |
| Концевые запоры 415 мм, U-штульп 8x28x8, FFH 2630-2815 мм | - | - | - | - | 212421 | 212422 | - | - | 212421 | 212422 |





| Штульповые механизмы и концевые запоры Дерево, смещение 13 мм, U-штульп 8x28x12 мм | 2НО-ВО | | 2MF+2I.S. | | 2MF+3I.S. K+1030 | | 2MF-BO | | 2MF-BO K+980 | |
|---|--------|--------|-----------|--------|------------------|--------|--------|--------|--------------|--------|
| | правые | левые | правые | левые | правые | левые | правые | левые | правые | левые |
| Штульповой механизм для дерева, фальцподот 12 мм, U-штульп 8x28x12 | 212423 | 212424 | 212427 | 212428 | 212429 | 212430 | 214212 | 214213 | 214214 | 214215 |
| Концевые запоры 125 мм, U-штульп 8x28x12, FFH 2040-2175 мм | 215860 | 215861 | 215860 | 215861 | - | - | 215860 | 215861 | - | - |
| Концевые запоры 260 мм, U-штульп 8x28x12, FFH 2175-2515 мм | 212433 | 212434 | 212433 | 212434 | - | - | 212433 | 212434 | - | - |
| Концевые запоры 415 мм, U-штульп 8x28x12, FFH 2330-2670 мм | 212435 | 212436 | 212435 | 212436 | - | - | 212435 | 212436 | - | - |
| Концевые запоры 125 мм, U-штульп 8x28x12, FFH 2340-2475 мм | - | - | - | - | 215860 | 215861 | - | - | 215860 | 215861 |
| Концевые запоры 260 мм, U-штульп 8x28x12, FFH 2475-2660 мм | - | - | - | - | 212433 | 212434 | - | - | 212433 | 212434 |
| Концевые запоры 415 мм, U-штульп 8x28x12, FFH 2630-2815 мм | - | - | - | - | 212435 | 212436 | - | - | 212435 | 212436 |

| Штульповые механизмы и концевые запоры Штульпов. механ. для противоложащего фурнит. паза ПВХ, U-8x28x8 | 2НО-ВО | | 2MF+2I.S. | | 2MF+3I.S. K+1030 | | 2MF-BO | | 2MF-BO K+980 | |
|---|--------|--------|-----------|--------|------------------|--------|--------|--------|--------------|--------|
| | правые | левые | правые | левые | правые | левые | правые | левые | правые | левые |
| Штульпов. механ. для противоложащего фурнит. паза ПВХ, смещение 13 мм, U-8x28x8 | 213115 | 213116 | 213119 | 213120 | 213121 | 213122 | 214216 | 214217 | 214218 | 214219 |
| Концевые запоры 125 мм, U-штульп 8x28x8, FFH 2040-2175 мм | 215862 | 215863 | 215862 | 215863 | - | - | 215862 | 215863 | - | - |
| Концевые запоры 260 мм, U-штульп 8x28x8, FFH 2175-2515 мм | 213621 | 213622 | 213621 | 213622 | - | - | 213621 | 213622 | - | - |
| Концевые запоры 415 мм, U-штульп 8x28x8, FFH 2330-2670 мм | 213623 | 213624 | 213623 | 213624 | - | - | 213623 | 213624 | - | - |
| Концевые запоры 125 мм, U-штульп 8x28x8, FFH 2340-2475 мм | - | - | - | - | 215862 | 215863 | - | - | 215862 | 215863 |
| Концевые запоры 260 мм, U-штульп 8x28x8, FFH 2475-2660 мм | - | - | - | - | 213621 | 213622 | - | - | 213621 | 213622 |
| Концевые запоры 415 мм, U-штульп 8x28x8, FFH 2630-2815 мм | - | - | - | - | 213623 | 213624 | - | - | 213623 | 213624 |

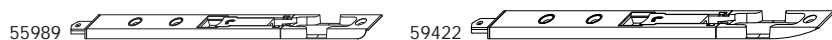

2НО-ВО = 2 крока - 2 штыря
 2MF+2I.S. = 2 мультифункциональных фалевых защёлки + 2 I.S. цапфы
 2MF+3I.S.+K+1030 = 2 мультифункциональных фалевых защёлки + 3 I.S. цапфы + K+1030

6.3 Дверной шпингалет





| 6.3.1 Дверной шпингалет, фальцлюфт 4 мм | |  |  |  | L |  | № | € |
|---|----|---|--|---|-----|---|--------|---|
| дер. . | | R8 | 18 | 8 | 255 | 20 | 208998 | |
| | | | | | 540 | 20 | 208999 | |
| фальцлюфт 4 мм . | | R8 | 11 | 8 | 255 | 20 | 58464 | |
| | | | | | 540 | 20 | 58468 | |
| | | | | | 255 | 20 | 55989 | |
| | | | | | 540 | 20 | 55985 | |
| | | R90 | 18 | 8 | 255 | 20 | 58467 | |
| | | | | | 540 | 20 | 58463 | |
| | | | | | 255 | 20 | 59422 | |
| | | | | | 540 | 20 | 59423 | |
| .нижн. лев. | R8 | 18 | 7 | 255 | 20 | 59424 | | |
| .нижн. прав. | R8 | 18 | 7 | 255 | 20 | 59425 | | |

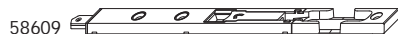

| 6.3.2 Дверной шпингалет, гладкий фальц | |  |  | L |  | № | € |
|--|-------------|--|---|-----|---|--------|---|
| . | глад. фальц | 18 | 10 | 200 | 20 | 210876 | |
| . | | | | 255 | 20 | 221097 | |





| 6.3.3 Дверной шпингалет, европаз | |  |  | L |  | № | € | |
|----------------------------------|-----------|--|---|-----|---|-------|-------|--|
| . | .лев. | паз 7/8/4 | 11 | 8 | 255 | 20 | 59428 | |
| | | паз 6/8/4 | 11 | 8 | 255 | 20 | 58609 | |
| | | паз 7/8/4 | 11 | 8 | 540 | 20 | 59430 | |
| | | паз 6/8/4 | 11 | 8 | 540 | 20 | 59426 | |
| | .прав. | паз 7/8/4 | 18 | 10 | 255 | 20 | 58575 | |
| | | паз 7/8/4 | 11 | 8 | 255 | 20 | 59429 | |
| | | паз 6/8/4 | 11 | 8 | 255 | 20 | 58608 | |
| | | паз 7/8/4 | 11 | 8 | 540 | 20 | 59431 | |
| | паз 6/8/4 | 11 | 8 | 540 | 20 | 59427 | | |
| | паз 7/8/4 | 18 | 10 | 255 | 20 | 58574 | | |



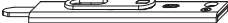

| 6.3.4 Принадлежности для шпингалетов | |  | № | € |
|--|--|---|--------|---|
| Концевая накладка для шпингалета | | 100 | 44268 | |
| Концевая подкладка в фурнитурный паз под левый шпингалет (-1 мм прижим) | | 50 | 44373 | |
| Концевая подкладка под правый шпингалет в фурнитурный паз (-1 мм прижим) | | 50 | 44372 | |
| Короткая подкладка под шпингалет в фурнитурный паз | | 100 | 44316 | |
| Подкладка для дверного шпингалета 200 мм лев. фурн. паз | | 20 | 360161 | |
| Подкладка для дверного шпингалета 200 мм прав. фурн. паз | | 20 | 360160 | |
| Подкладка для дверного шпингалета 200 мм фурн. паз | | 20 | 360159 | |
| Подкладка для дверного шпингалета фурн. паз Цвет: Серебро | | 50 | 44253 | |

213832 

| 6.3.5 Дверной шпингалет, U-профиль 6x24x6 мм | |  |  | L |  | № | € |
|--|--------|---|--|-----|---|--------|---|
| гл. фальц 24, смещ. 13 мм . | .лев. | 20 | 10 | 120 | 20 | 213832 | |
| | .прав. | 20 | 10 | 120 | 20 | 213831 | |
| для фурн. паза MD . | .лев. | 20 | 10 | 120 | 20 | 213830 | |
| | .прав. | 20 | 10 | 120 | 20 | 213829 | |
| фальцлюфт 4, смещ. 13 мм . | .лев. | 20 | 10 | 120 | 20 | 213834 | |
| | .прав. | 20 | 10 | 120 | 20 | 213833 | |

213826 

| 6.3.6 Дверной шпингалет, U-профиль 6x32x6 мм | |  |  | L |  | № | € |
|--|--------|---|--|-----|---|--------|---|
| фурн. паз . | .лев. | 20 | 10 | 130 | 20 | 213826 | |
| | .прав. | 20 | 10 | 130 | 20 | 213825 | |

MACO
PROTECT



Штульповые механизмы и дверные шпингалеты



7 Принадлежности и шаблоны

| | | |
|-----|----------------|-----|
| 7.1 | Принадлежности | 114 |
| 7.2 | Шаблоны | 115 |

7 Принадлежности и шаблоны

7.1 Принадлежности

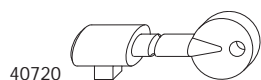

40720

7.1.1 Монтажный ключ



№

€

Монтажный ключ

20

40720



43647

4 mm

7.1.2 Регулировочный ключ



№

€

Регулировочный ключ шестигранный 4 мм, изогнут, второй торец-Т15

100

43647

7.2 Шаблоны

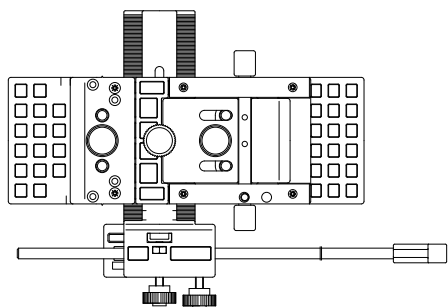

28603

7.2.1 Сверильный шаблон



№

€

Сверильный шаблон для коробки дверного замка

1

28603



7.2.2 Фрезеровальный шаблон для дерева BASIC

| Шаблон | Смещение (мм) | к дверному замку | Артикул |
|--|---------------|----------------------|---------|
| Фрезеровальный шаблон для дерева BASIC | 9 | Z-TS Modul 2/4 HO-BO | 458238 |
| | | Z-TF 2MF+2/4i.S. | 458240 |
| | | Z-TS 4i.S. | 458242 |
| | 13 | Z-TS Modul 2/4 HO-BO | 458239 |
| | | Z-TF 2MF+2/4i.S. | 458241 |
| | | Z-TS 4i.S. | 458243 |

Руководства по монтажу находятся на www.maco.ru

HO-BO = Направление запираения крюков - вверх
 MF = Мультифункциональная фалевая защёлка
 i.S = i.S. цапф



**7.2.3 Фрезеровальный шаблон
PROTECT Modul для ПВХ**

| Шаблон | к дверному замку | для профиля | Артикул |
|--|-------------------------|-------------------------------|----------------|
| Фрезеровальный шаблон створки с фурнитурным пазом, ПВХ | Z-TS Modul 2/4 HO-BO | - | 458188 |
| Шаблон для фрезерования пазов под запорные планки | Z-TS Modul 2/4 HO-BO | Aluplast 2000 | 458189 |
| | | Aluplast 4000/5000 | 458190 |
| | | Brüggmann AD | 458191 |
| | | Brüggmann AD 20V | 458192 |
| | | Gealan S3000/7000/8000 | 458193 |
| | | KBE System 70AD | 458194 |
| | | Kömmerling Eurofutur | 458195 |
| | | Rehau S730 | 458196 |
| | | Salamander 2D/3D | 458197 |
| | | Schüco CT70 | 458198 |
| | | Thyssen AD/Prestige | 458199 |
| | | Trocal Innonova A3/A5/Confort | 458200 |
| | | Veka Topline NE | 458201 |
| | | Veka Topline HT | 458202 |

Руководства по монтажу находятся на www.maco.ru

HO-BO = Направление запираения крюков - вверх

MACO
PROTECT



Принадлежности и шаблоны



8 Дверные замки В-TV

| | | |
|-----|--|-----|
| 8.1 | Дверной замок В-TV ММ _____ | 120 |
| 8.2 | Дверной замок В-TV _____ | 122 |
| 8.3 | Дверной замок В-TV фиксированный _____ | 126 |

8 Дверные замки B-TV

8.1 Дверной замок B-TV MM

8.1.1 Монтажная схема замка B-TV MM

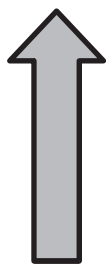



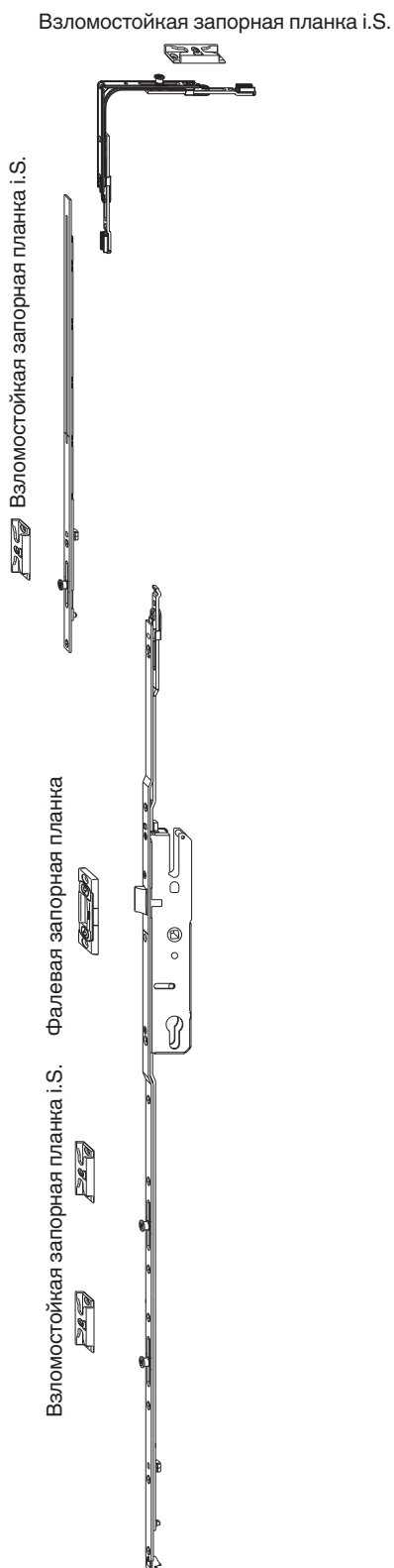
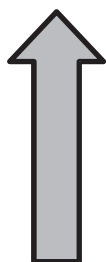



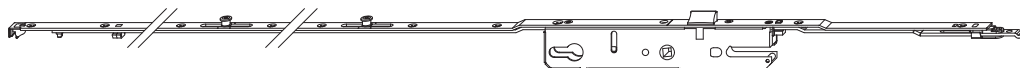

Направление запираения вверх



 Возможна комбинация с элементами оконной поворотной фурнитуры Multi Matic







203828



| 8.1.2 Дверной замок B-TV E 92 с профильным цилиндром для ММ |  |  |  |  |  |  |  | № | € |
|---|---|---|---|---|--|---|---|--------|---|
| ММ не удлиняемый | 25 | 8 | 1.050 | 2 | 1.347 | 92 | 5 | 203828 | |
| | 28 | 8 | 1.050 | 2 | 1.347 | 92 | 5 | 203696 | |
| | 35 | 8 | 1.050 | 2 | 1.347 | 92 | 5 | 203829 | |
| | 40 | 8 | 1.050 | 2 | 1.347 | 92 | 5 | 203830 | |
| | 45 | 8 | 1.050 | 2 | 1.347 | 92 | 5 | 203831 | |
| | 50 | 8 | 1.050 | 2 | 1.347 | 92 | 5 | 203832 | |
| | 55 | 8 | 1.050 | 2 | 1.347 | 92 | 5 | 203833 | |





203840



| 8.1.3 Дверной замок B-TV E 94 с круглым цилиндром для ММ |  |  |  |  |  |  |  | № | € |
|--|---|---|---|---|--|---|---|--------|---|
| ММ не удлиняемый | 28 | 8 | 1.050 | 2 | 1.347 | 94 | 5 | 203840 | |
| | 35 | 8 | 1.050 | 2 | 1.347 | 94 | 5 | 203841 | |
| | 40 | 8 | 1.050 | 2 | 1.347 | 94 | 5 | 203842 | |
| | 45 | 8 | 1.050 | 2 | 1.347 | 94 | 5 | 203843 | |
| | 50 | 8 | 1.050 | 2 | 1.347 | 94 | 5 | 203844 | |
| | 55 | 8 | 1.050 | 2 | 1.347 | 94 | 5 | 203845 | |

203697



| 8.1.4 Удлинитель штупля ММ |  |  |  |  | № | € |
|----------------------------|---|--|---|---|--------|---|
| Удлинитель штупля B-TV ММ | 1.701 - 1.950 | 497 | 1 | 10 | 203697 | |
| | 1.951 - 2.200 | 747 | 1 | 10 | 203698 | |
| | 2.201 - 2.450 | 997 | 2 | 10 | 203699 | |

94322



| 8.1.5 Запорная планка для фалевой защёлки |  | № | € |
|---|---|-------|---|
| Запорная планка под фалевую защелку для штупля механизма дерево/ПВХ 1 паз фикс. . | 50 | 35178 | |
| Запорная планка под фалевую защелку паз 6/8/4 регулир. . | 50 | 94322 | |
| Запорная планка под фалевую защелку фальц 18 мм регулир. . | 50 | 38924 | |
| Запорная планка под фалевую защелку фальцлюфт 4 мм регулир. . | 50 | 94118 | |

222201

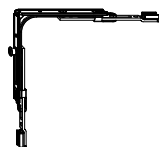

| 8.1.6 Угловой соединитель ММ |  |  | № | € |
|------------------------------|---|---|--------|---|
| Угловой переключатель, ММ | 1 | 50 | 222201 | |

8.2 Дверной замок B-TV

8.2.1 Монтажная схема замка B-TV



Направление запираения вверх

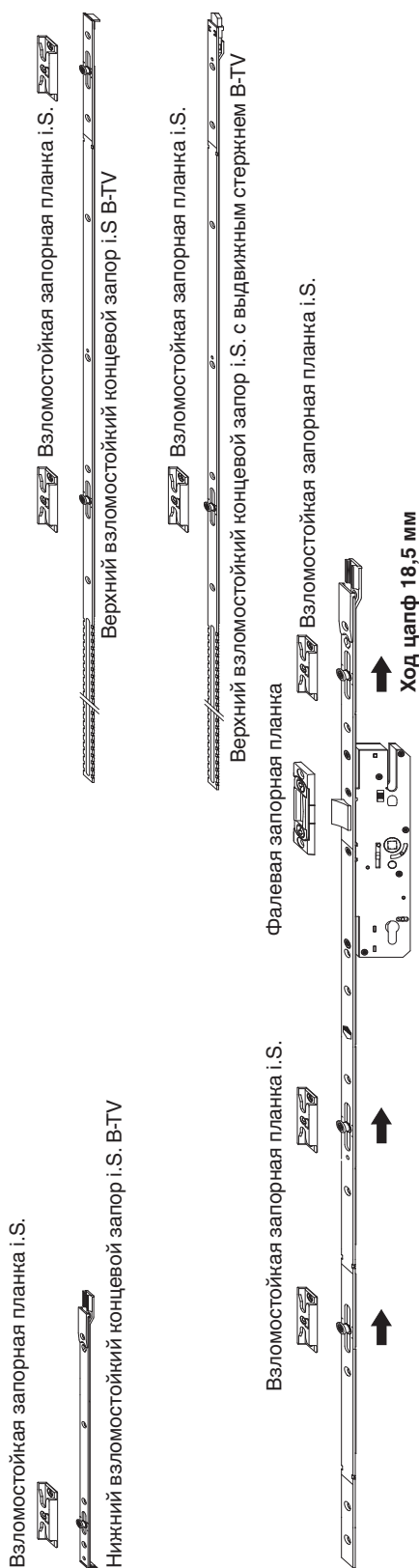

Возможна комбинация с элементами оконной поворотной фурнитуры Multi Trend

8.2.2 E92 PZ профильный цилиндр

220298



8.2.2.1 Дверной замок B-TV с i.S. цапфами

| | | | | | L | | | № | € |
|------------|----|---|-------|---|-------|----|---|--------|---|
| удлиняемый | 25 | 8 | 1.050 | 3 | 1.460 | 92 | 5 | 201455 | |
| | 28 | 8 | 1.050 | 3 | 1.460 | 92 | 5 | 59900 | |
| | 35 | 8 | 1.050 | 3 | 1.460 | 92 | 5 | 220298 | |
| | 40 | 8 | 1.050 | 3 | 1.460 | 92 | 5 | 220299 | |
| | 45 | 8 | 1.050 | 3 | 1.460 | 92 | 5 | 59901 | |
| | 50 | 8 | 1.050 | 3 | 1.460 | 92 | 5 | 57179 | |
| | 55 | 8 | 1.050 | 3 | 1.460 | 92 | 5 | 201459 | |

58188

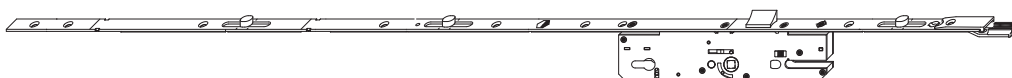

8.2.2.2 Дверной замок B-TV с овальными запорными цапфами

| | | | | | L | | | № | € |
|------------|----|---|-------|---|-------|----|---|-------|---|
| удлиняемый | 25 | 8 | 1.050 | 3 | 1.460 | 92 | 5 | 58188 | |
| | 28 | 8 | 1.050 | 3 | 1.460 | 92 | 5 | 55395 | |
| | 35 | 8 | 1.050 | 3 | 1.460 | 92 | 5 | 55396 | |
| | 40 | 8 | 1.050 | 3 | 1.460 | 92 | 5 | 55397 | |
| | 45 | 8 | 1.050 | 3 | 1.460 | 92 | 5 | 55398 | |
| | 50 | 8 | 1.050 | 3 | 1.460 | 92 | 5 | 55399 | |
| | 55 | 8 | 1.050 | 3 | 1.460 | 92 | 5 | 55399 | |

8.2.3 E92 RZ круглый цилиндр

201457

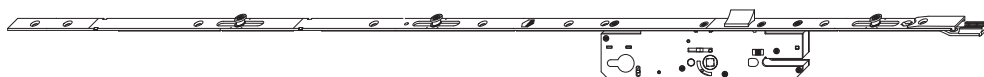

8.2.3.1 Дверной замок B-TV с i.S. цапфами

| | | | | | L | | | № | € |
|------------|----|---|-------|---|-------|----|---|--------|---|
| удлиняемый | 28 | 8 | 1.050 | 3 | 1.460 | 94 | 5 | 201457 | |
| | 35 | 8 | 1.050 | 3 | 1.460 | 94 | 5 | 55484 | |
| | 40 | 8 | 1.050 | 3 | 1.460 | 94 | 5 | 55485 | |
| | 45 | 8 | 1.050 | 3 | 1.460 | 94 | 5 | 55486 | |
| | 50 | 8 | 1.050 | 3 | 1.460 | 94 | 5 | 57181 | |
| | 55 | 8 | 1.050 | 3 | 1.460 | 94 | 5 | 55487 | |

59391

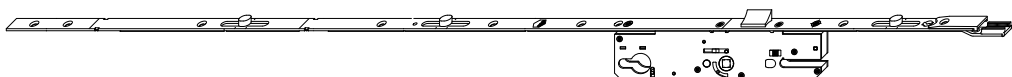

8.2.3.2 Дверной замок B-TV с овальными цапфами

| | | | | | L | | | № | € |
|------------|----|---|-------|---|-------|----|---|-------|---|
| удлиняемый | 28 | 8 | 1.050 | 3 | 1.460 | 94 | 5 | 59391 | |
| | 35 | 8 | 1.050 | 3 | 1.460 | 94 | 5 | 55146 | |
| | 40 | 8 | 1.050 | 3 | 1.460 | 94 | 5 | 55147 | |
| | 45 | 8 | 1.050 | 3 | 1.460 | 94 | 5 | 55148 | |
| | 50 | 8 | 1.050 | 3 | 1.460 | 94 | 5 | 55149 | |
| | 55 | 8 | 1.050 | 3 | 1.460 | 94 | 5 | 55149 | |

8.2.4 Верхние концевые запоры без выдвижного стержня

55488 

8.2.4.1 Верхний концевой запор без выдвижного стержня с i.S. цапфами



№ €

| | | | | | | |
|---------------|-------|----|---|----|--------------------|--|
| 1.850 - 2.100 | 650 | 16 | 1 | 10 | 55488 ¹ | |
| 2.101 - 2.350 | 900 | 16 | 1 | 10 | 55489 ¹ | |
| 2.351 - 2.600 | 1.150 | 16 | 2 | 10 | 55490 ¹ | |

¹ Возможна комбинация с элементами фурнитуры для поворотного окна.

55169 

8.2.4.2 Верхний концевой запор без выдвижного стержня с овальными цапфами



№ €

| | | | | | | |
|---------------|-------|----|---|----|--------------------|--|
| 1.850 - 2.100 | 650 | 16 | 1 | 10 | 55169 ¹ | |
| 2.101 - 2.350 | 900 | 16 | 1 | 10 | 55170 ¹ | |
| 2.351 - 2.600 | 1.150 | 16 | 2 | 10 | 55171 ¹ | |

¹ Возможна комбинация с элементами фурнитуры для поворотного окна.

8.2.5 Верхние концевые запоры с выдвижным стержнем

55215 

8.2.5.1 Верхний концевой запор с выдвижным стержнем с i.S. цапфами



№ €

| | | | | | | |
|---------------|-------|----|---|----|--------|--|
| 1.850 - 2.100 | 650 | 16 | 0 | 10 | 55215 | |
| 2.101 - 2.350 | 900 | 16 | 0 | 10 | 55216 | |
| 2.351 - 2.600 | 1.150 | 16 | 1 | 5 | 201458 | |

55217 

8.2.5.2 Верхний концевой запор с выдвижным стержнем с овальными цапфами



№ €

| | | | | | | |
|---------------|-------|----|---|----|-------|--|
| 2.351 - 2.600 | 1.150 | 16 | 1 | 10 | 55217 | |
|---------------|-------|----|---|----|-------|--|



8.2.6 Нижние концевые запоры без выдвижного стержня

55491 

| 8.2.6.1 Нижний концевой запор без выдвижного стержня с i.S. цапфами |  | L |  |  |  | № | € |
|---|---|-----|---|---|---|--------------------|---|
| . | 1.850 - 2.600 | 400 | 16 | 1 | 10 | 55491 ¹ | |

¹ Возможна комбинация с элементами фурнитуры для поворотного окна.

55172 

| 8.2.6.2 Нижний концевой запор без выдвижного стержня с овальными цапфами |  | L |  |  |  | № | € |
|--|---|-----|---|---|---|--------------------|---|
| . | 1.850 - 2.600 | 400 | 16 | 1 | 10 | 55172 ¹ | |

¹ Возможна комбинация с элементами фурнитуры для поворотного окна.

94322 

| 8.2.7 Запорные планки для фалевой защёлки |  | № | € |
|--|---|-------|---|
| Запорная планка под фалевую защелку для ступль. механизма дерево/ПВХ 1 паз фикс. . | 50 | 35178 | |
| Запорная планка под фалевую защелку паз 6/8/4 регулир. . | 50 | 94322 | |
| Запорная планка под фалевую защелку фальц 18 мм регулир. . | 50 | 38924 | |
| Запорная планка под фалевую защелку фальцлюфт 4 мм регулир. . | 50 | 94118 | |

8.3 Дверной замок B-TV фиксированный

8.3.1 Монтажная схема замка B-TV фиксированный

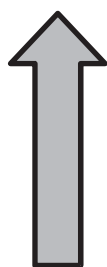

Направление запираения вверх

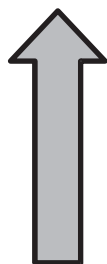

 Взломостойкая запорная планка i.S.



Верхний взломостойкий концевой запор i.S B-TV

 Взломостойкая запорная планка i.S.



Верхний концевой запор с выдвижным стержнем B-TV

 Взломостойкая запорная планка i.S.



Фалевая запорная планка



 Взломостойкая запорная планка i.S.

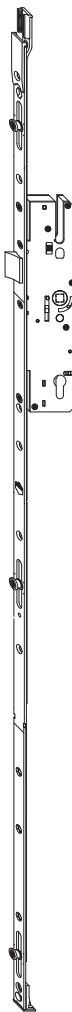

 Возможна комбинация с элементами оконной поворотной фурнитуры Multi Trend

8.3.2 E92 PZ профильный цилиндр

204049

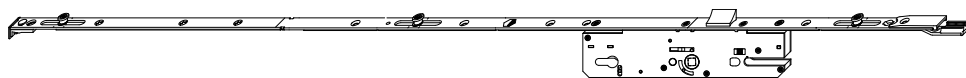

8.3.2.1 Дверной замок B-TV с i.S. цапфами

| | | | | | L | | | № | € |
|---------------|----|---|-------|---|----------|----|---|----------|----------|
| не удлиняемый | 25 | 8 | 1.050 | 3 | 1.460 | 92 | 5 | 204060 | |
| | 28 | 8 | 1.050 | 3 | 1.460 | 92 | 5 | 204048 | |
| | 35 | 8 | 1.050 | 3 | 1.460 | 92 | 5 | 204049 | |
| | 40 | 8 | 1.050 | 3 | 1.460 | 92 | 5 | 204050 | |
| | 45 | 8 | 1.050 | 3 | 1.460 | 92 | 5 | 204051 | |
| | 50 | 8 | 1.050 | 3 | 1.460 | 92 | 5 | 204052 | |
| | 55 | 8 | 1.050 | 3 | 1.460 | 92 | 5 | 204053 | |

55488

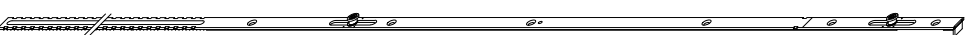

8.3.3 Верхний концевой запор без выдвигающего стержня с i.S. цапфами

| | | L | | | | № | € |
|--|---------------|----------|----|---|----|--------------------|----------|
| | 1.850 - 2.100 | 650 | 16 | 1 | 10 | 55488 ¹ | |
| | 2.101 - 2.350 | 900 | 16 | 1 | 10 | 55489 ¹ | |
| | 2.351 - 2.600 | 1.150 | 16 | 2 | 10 | 55490 ¹ | |

¹ Возможна комбинация с элементами фурнитуры для поворотного окна.

201458



8.3.4 Верхний концевой запор с выдвигающим стержнем с i.S. цапфами

| | | L | | | | № | € |
|--|---------------|----------|----|---|----|----------|----------|
| | 1.850 - 2.100 | 650 | 16 | 0 | 10 | 55215 | |
| | 2.101 - 2.350 | 900 | 16 | 0 | 10 | 55216 | |
| | 2.351 - 2.600 | 1.150 | 16 | 1 | 5 | 201458 | |

94322



8.3.5 Запорные планки для фалевой защёлки

| | | № | € |
|---|----|----------|----------|
| Запорная планка под фалевую защелку для шульп. механизма дерево/ПВХ 1 паз фикс. . | 50 | 35178 | |
| Запорная планка под фалевую защелку паз 6/8/4 регулир. . | 50 | 94322 | |
| Запорная планка под фалевую защелку фальц 18 мм регулир. . | 50 | 38924 | |
| Запорная планка под фалевую защелку фальцлюфт 4 мм регулир. . | 50 | 94118 | |

**MACO
PROTECT**



Дверные замки B-TV



9 Шпингалет для межкомнатных дверей

9

| | | |
|-----|---|-----|
| 9.1 | Шпингалет для межкомнатных дверей, фальцлюфт 4 мм _____ | 130 |
| 9.2 | Запорные планки под шпингалет для межкомнатных дверей _____ | 130 |
| 9.3 | Принадлежности для шпингалетов _____ | 130 |

9 Шпингалет для межкомнатных дверей

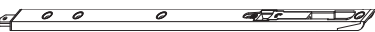
57916 

| 9.1 Шпингалет для межкомнатных дверей, фальцлюфт 4 мм |  |  |  | L |  | № | € |
|---|---|--|---|-----|---|--------|---|
| | R8 | 12 | 8 | 600 | 20 | 58465 | |
| | R90 | 12 | 8 | 540 | 20 | 59433 | |
| фальцлюфт 4 мм . | R8 | 12 | 8 | 255 | 20 | 57915 | |
| | | | | 425 | 20 | 57916 | |
| | | | | 540 | 20 | 209000 | |
| | R90 | 12 | 8 | 255 | 20 | 58029 | |
| | | | | 425 | 20 | 58030 | |
| | | | | 600 | 20 | 58469 | |



| 9.2 Запорные планки под шпингалет для межкомнатных дверей |  | № | € |
|---|---|-------|---|
| Вертный цилиндр . . | 100 | 94219 | |
| Запорная буска . | 20 | 59432 | |
| Ригельная запорная планка Высота = 2,5 мм . | 50 | 34051 | |



| 9.3 Принадлежности для шпингалетов |  | № | € |
|--|---|-------|---|
| Концевая накладка для шпингалета | 100 | 44268 | |
| Концевая подкладка в фурнитурный паз под левый шпингалет (-1 мм прижим) | 50 | 44373 | |
| Концевая подкладка под правый шпингалет в фурнитурный паз (-1 мм прижим) | 50 | 44372 | |
| Короткая подкладка под шпингалет в фурнитурный паз | 100 | 44316 | |
| Подкладка для дверного шпингалета фурн. паз Цвет: Серебро | 50 | 44253 | |



10 Технические данные и документация

| | | |
|------|---|-----|
| 10.1 | Инновационное решение MACO Hutstulp _____ | 132 |
| 10.2 | MACO Защита поверхности _____ | 134 |
| 10.3 | ISO - сертификат _____ | 137 |
| 10.4 | lft - сертификат _____ | 138 |
| 10.5 | PFB - сертификат _____ | 140 |
| 10.6 | SKG - сертификат _____ | 141 |
| 10.7 | Общая продукт-информация _____ | 142 |

10 Технические данные и документация

10.1 Инновационное решение MACO Hutstulp

Инновационное решение MACO-Hutstulp

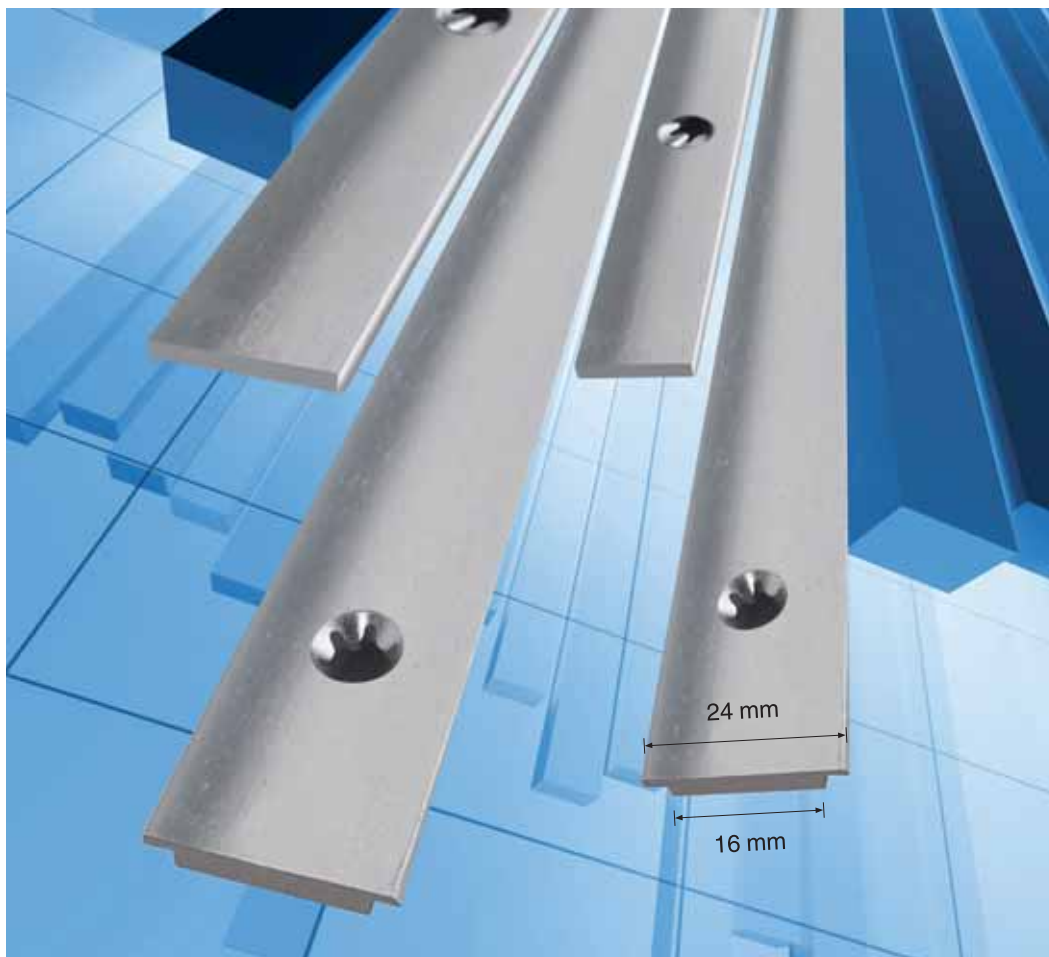

Техническое развитие системы штаulpов

Преимущества

- Надёжная конструкция и оригинальный вид внешнего плоского штаульпа шириной 24 мм в сочетании с внутренним пазом 16 мм
- Не требуется уменьшение люфта между створкой и рамой как, например, при использовании плоского штаульпа 24 x 3 мм
- Отсутствие загрязнений в зазоре между штаульпом и фурнитурным пазом
- Возможно применение высококачественных запорных планок PROTECT
- Все имеющиеся фрезеровки под коробку замка надёжно закрываются
- Более высокая стабильность, чем у плоского штаульпа 16 x 3 мм
- Простой монтаж и типовое позиционирование саморезов как и на стандартном штаульпе

Преимущества Hutstulp (F-24/16x3мм)

Отсутствие загрязнений в зазоре между шульпом и фурнитурным пазом

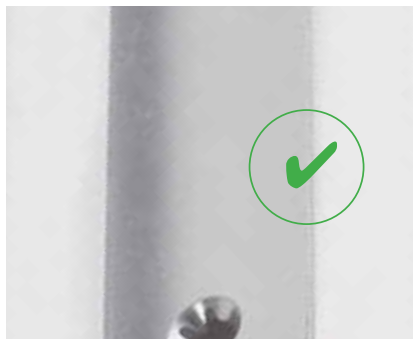

Все имеющиеся фрезеровки под коробку замка надёжно закрываются

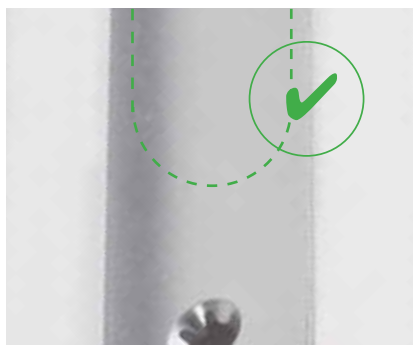
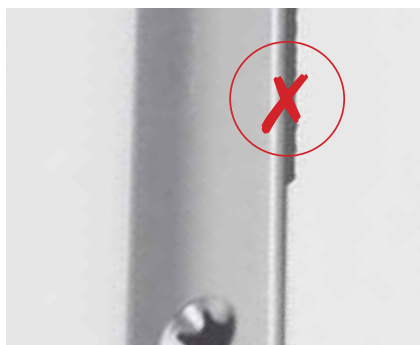

Не требуется уменьшение люфта между створкой и рамой как, например, при использовании плоского шульпа 24 x 3 мм

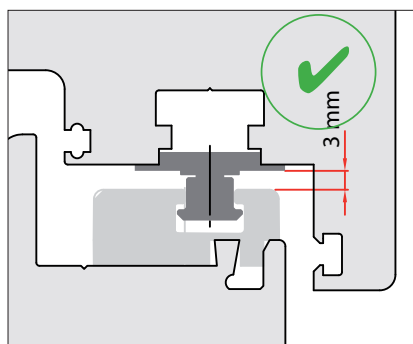
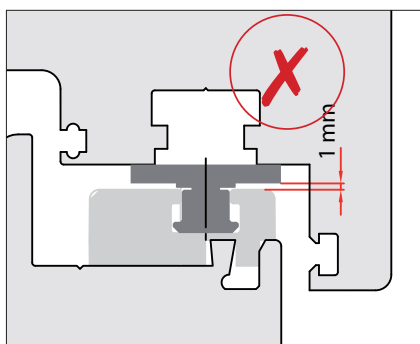



10.2 MACO Защита поверхности

MACO Silber - Look

Фирма MACO, как первый производитель фурнитуры для строительства в 2000г. применила гальваническую оцинковку 6-валентным хромом, имевший тогда свободное применение и в последующим при обнаружении вреда для окружающей среды, фирма отказалась от данного соединения. Выбор данного пути развития принес исключительный результат для свойств поверхности и первой альтернативой 6 валентному хрому стало хромирование. Детали фурнитуры из стали, например вылитые из цинка, оцинковывались, пассивировались и опечатывались. Стала достигнута высокая коррозионная стойкость и при этом без ущерба для окружающей среды. Через новые инвестиции и постоянное развитие особенно в области гальванотехнологий компанией MACO было разработано новое Нано-Структурированное кремнеевое соединение, которое соответствовало 4 классу соответствующих для покрытия норм EN 1670:2007. Не в последнюю очередь речь идет о высказанном экологически безопасном процессе гальванопокрытия который не предусматривает использование 6-ти валентного хрома.

Область применения

Гальваническая оцинковка фурнитуры, как было доказано, лучше всего подходит для нормальных условий эксплуатации. Однако там где предъявляются высокие требования к фурнитуре, например: объекты с повышенной влажностью, сель. хоз. объекты, прибрежные зоны морей, некоторые породы древесины и т.д. фурнитура такого типа не подходит. Агрессивная среда вызывает различные негативные химические реакции на цинковом покрытии. И в данном случае рекомендуется использовать фурнитуру MACO TRICOAT

Выгоды для переработчиков:

- a) высококачественное покрытие Silber-look
- b) высокая коррозионная стойкость поверхности по 4 классу в соответствии с нормами EN 1670:2007
- c) безопасное влияние на окружающую среду / используется для широкой области применения
- d) проверенное качество и аккредитация через внешние испытания в исследовательских центрах и пройденные внутренние испытания, например: испытание в соляном тумане по DIN EN ISO 9227, испытания в окружающей среде, и т.д.
- e) лидер качества поверхности за счет многолетнего опыта в области гальванической оцинковки
- f) собственное производство, состоящее из 10 гальванических устройств, обладающих передовыми

технологиями обработки поверхности оконных и дверных механизмов.

MACO Tricoat

Фурнитура Maco Tricoat разработана для специальной области применения где необходима повышенная защита от коррозии Поверхность фурнитуры Maco Tricoat также как и фурнитура Silber-look оцинковывается, далее на нее наносится

органический слой Top-Coat (MKS-микрорезистентный слой). Благодаря лаковой системе фурнитура Maco Tricoat достигает высокая стойкость к химическому воздействию и намного превосходит коррозионную стойкость фурнитуры с гальваническим покрытием

Высокая коррозионная стойкость на действие окружающей среды

Качество фурнитуры Maco Tricoat соответствует классу ? 5 нормативных документов EN 1670:2007. Испытания в соляной камере, проходившие в исследовательских институтах по системе EN ISO 9227 официально установили и аккредитовали

Также как и покрытие Maco Silber-look данное покрытие является безопасным для окружающей среды, это было достигнуто путем отказа от применения шестивалентного хрома.

Область применения

Везде, где является недостаточным простое оцинкованное покрытие, например у морских берегов, в промышленных населенных пунктах, в помещениях с повышенной влажностью, цеха и везде, где имеет место высокое коррозионное воздействие

древесные породы с содержанием кислот (дуб, Ассоса...), крытые бассейны, промышленные предприятия: сыроварни, сель. хоз. объекты и т.д.

Выгоды для переработчиков:

- a) дифференцированные отличительные особенности
- b) внешний вид не имеющий аналогов
- c) долговечность в экстремальных условиях
- d) высокая коррозионная стойкость
- e) проверенное качество за счет аккредитации по результатам испытаний, например по результатам внутренних испытаний по нормам DIN EN ISO 9227, испытания в атмосферных условиях и т.д.
- f) нет возникновения коррозии на этапе строительства
- g) незначительные рекламации



- h) использование в проблемных ситуациях
- i) 10 лет гарантии на поверхность при применении на деревянных породах с дубильной кислотой

Описание действия защитного покрытия

Можно гарантировать безупречное функционирование оконной фурнитуры, если соблюсти ряд требований. При этом конечный потребитель получает удовольствие от безупречной работы окна и внешнего вида фурнитуры.

Причины коррозии на фурнитуре

Перед тем как решить какое выбрать защитное покрытие для фурнитуры нужно понять причины появления коррозии. Итак, причиной коррозии являются:

- a) Первоначальной причиной коррозии является воздух. Практика показывает, что коррозия наступает тогда, когда относительная влажность воздуха достигает критической отметки от 60 до 70 %.
- b) В дальнейшем причиной коррозии является образование конденсата на поверхности фурнитуры, причиной тому служит высокое колебание температур.
- c) Усиливает коррозию загрязненный воздух (промышленные зоны, загазованность от автомобилей), так например сернистый газ (SO_2) и угарный газ (NO_2) при взаимодействии с влажной средой образуются такие соединения как сернистая кислота (HS_2SO_3), серная кислота (H_2SO_4), азотная кислота (HNO_3). Загрязненный воздух даже в сухой среде также может являться причиной коррозии.
- d) С проблемой, указанной в пункте c) сталкиваются объекты построенные у проезжих частей, промышленных зон, очистных сооружений, вблизи воздействия морского воздуха, в хлоросодержащей среде, объекты животноводческих ферм.
- e) Такие безвредные материалы как, например бумага/ картон а также используемое в оконном производстве дерево содержат в себе агрессивные вещества (кислота, щелочь, хлориды), контакт данных веществ разрушает слой пассивации и вызывает коррозию.
- f) Гипсовая штукатурка, цемент и другой строительный материал, или такой широко применяемый материал как силикон, являются также причинами коррозии.
- g) За частую не достаточно обращать внимание на один источник причиняющий вред фурнитуре, такой как например моющие средства, (уксус, кислоты содержащие очистители с лимонной кислотой, цементные порошки с фосфорной кислотой, сильные щелочные очистители и т.д.), но также необходимо учитывать и средства причиняющие механический ущерб (чистящее средство, стальная губка) во всех случаях слой пассивации разрушается и таким образом ускоряется процесс поражения деталей коррозией.

Мероприятия по сохранению поверхности для того чтобы избежать ситуации с влажной средой в фальцевом пространстве

- b) Налет на фурнитуре может образоваться при строительстве от (строительной пыли, гипсовой штукатурки, цемента, и т.д.) во время проветривания помещения, когда окно открыто.

d) Если окно изготовлено из дерева - дуба, то в раме и створке присутствует дубильная кислота, в этом случае также необходимо побеспокоиться об установке фурнитуры с соответствующим защитным покрытием поскольку дубильная кислота полностью не испаряется с поверхности дерева.

- f) Для протирки и полировки фурнитуры разрешено применять только мягкие РН - нейтральные чистящие средства.

g) Фурнитуру нельзя повреждать угловатым или острым монтажным инструментом.

Более подробную информацию вы можете найти на нашей интернет-странице или в проспекте Арт.-№г. 495



10.4 Ift - сертификат



ift-KONFORMITÄT SZERTIFIKAT
ift-CERTIFICATE OF CONFORMITY



Mehrfachverriegelungen / Multi locking system

| | |
|--|--|
| <p>Produktfamilien <i>product families</i></p> <p>Produktfamilien <i>product families</i></p> <p>Einsatzbereich <i>field of application</i></p> <p>Hersteller <i>manufacturer</i></p> <p>Produktionsstandort <i>production site</i></p> | <p>Mehrfachverriegelungen für Türen nach EN 14351-1 <i>multi locking system for doors according EN 14351-1</i></p> <p>Mehrfachverriegelungsschloss Z-TS Mehrfachverriegelungsschloss Z-TF</p> <p>Türen aus Holz, Kunststoff, Stahl und Aluminium <i>doors with material of PVC, wood, steel and aluminium</i></p> <p>Mayer & Co. Beschläge GmbH, Alpenstraße 173, A – 5020 Salzburg</p> <p>Maco Baubeschlag GmbH, Steindorf 67, A-5570 Mauterndorf im Lungau</p> |
|--|--|



Mit diesem Zertifikat wird bescheinigt, dass die benannten Mehrfachverriegelungen den Anforderungen des Ift-Zertifizierungsprogramms für Schlösser und Mehrfachverriegelungen (QM 342 : 2000) entsprechen.

Grundlagen sind durch das Prüflabor erstellte Produktfamilien der aufgeführten Mehrfachverriegelungen, eine Prüfung durch das Prüflabor nach DIN 15251-3, eine werksseitige Produktionskontrolle des Herstellers und eine Fremdüberwachung der Fertigung durch die Überwachungsstelle in den benannten Standorten.

Die Gültigkeitsdauer des Zertifikates beträgt 5 Jahre. Mit der Erteilung des Zertifikates ist eine regelmäßige Fremdüberwachung des Herstellers verbunden.

Das Zertifikat darf nur unverändert vervielfältigt werden. Alle Änderungen der Voraussetzungen für die Zertifizierung sind dem Ift-Zert mit den erforderlichen Nachweisen unverzüglich schriftlich anzuzeigen.

Das Unternehmen ist berechtigt, die Mehrfachverriegelungen gemäß der Ift-Zeichensatzung mit dem „Ift-zertifiziert“-Zeichen zu kennzeichnen.

Dieses Zertifikat enthält 2 Anlagen:
1: Übersicht der Produktfamilien
2: Austauschbarkeit nach EN 14351-1

The present certificate attests that the multi lock system mentioned fulfils the requirements of the Ift-certification scheme for locks and multi locking systems (QM 342 : 2000).

Basis of the certificate are the product families of the multi locking system listed that have been compiled by the test laboratory, tests performed by the test laboratory as per DIN 15251-3, factory production control by the manufacturer and third-party surveillance audits of the production by the surveillance body at the plants mentioned.

The certificate is valid for a period of 5 years. Award of the certificate is tied to regular third-party surveillance of the manufacturer.

The reproduction of the certificate without any change whatsoever from the original, is permitted. Any changes to the prerequisites applicable to certification shall be immediately communicated in writing to Ift-Zert accompanied by the necessary evidence.

The company is authorised to affix the "Ift-certified"-mark to the multi locking system according to the "Ift rules for use of the "Ift-certified"-mark.

This certificate contains 2 Annexes:
1: List of product families
2: Interchangeability as per EN 14351-1

Rosenheim
01. Februar 2010.



Andreas Matschi
Leiter Ift Zertifizierungs- und Überwachungsstelle
Head of Ift Certification and Surveillance Body

Vertrag-Nr. / Contract No.: 230 6036771

Zertifikat-Nr. / Certificate No.: 230 6036771-1-1
Gültig bis / Valid: 31.01.2015



ift Rosenheim GmbH
Zertifizierungsstelle
Theodor-Greif-Str. 7-9
83026 Rosenheim
Germany



DAP-22-2268 00





DAP-25-0268 00

Nachweis

Einsteckschlösser als Mehrfachverriegelung
gemäß DIN 18251-3 : 2002-11

Prüfbericht Nr. 207 41344



Auftraggeber **Mayer & CO Beschläge GmbH**
Alpenstraße 173

A-5020 Salzburg

Grundlagen

DIN 18251-3:2002-11 Schlösser – Einsteckschlösser Teil 3: Einsteckschlösser als Mehrfachverriegelung

| | |
|---------------------|--|
| Schloss | Mehrfachverriegelung |
| Produktbezeichnung | 3-Fallenschloss Z-TF |
| Dornmaß | 40 mm bis 80 mm |
| Entfernung | 92 mm und 85 mm |
| Stulp | 16 mm x 3 mm bis 24 mm x 3 mm / Flach- und Hut-Stulp |
| Falle | Kreuzfalle, Fallenausschluss ca. 11 mm |
| Riegelwerk | 2-tourig; Riegelausschluss ca. 20 mm |
| Vierkant | 8 mm und 10 mm |
| Montage und Wartung | Gemäß den Vorgaben der Firma Mayer & CO Beschläge GmbH |
| Besonderheit | Das Schloss mit dem Dornmaß 35 mm hat den Nachweis erbracht, kann nicht klassifiziert werden, da der Riegelausschluss kleiner 20 mm ist. |

Darstellung



Verwendungshinweise

Dieser Prüfbericht dient zum Nachweis der Anforderungen von Schlössern nach DIN 18251-3:2002-11

Dieser Prüfbericht ersetzt nicht das EG-Konformitätszertifikat.

Dieser Prüfbericht dient nicht für den Nachweis für Fluchttüren, Schließblech und Befestigungsmittel.

Gültigkeit

Die genannten Daten und Ergebnisse beziehen sich ausschließlich auf die geprüften Schlösser.

Veröffentlichungshinweise

Es gilt das ift-Merkblatt „Bedingungen und Hinweise zur Benutzung von ift-Prüfdocumentationen“.

Das Deckblatt kann als Kurzfassung verwendet werden.

Inhalt

Der Nachweis umfasst insgesamt 35 Seiten

- 1 Gegenstand
- 2 Durchführung
- 3 Einzelergebnissen
- 4 Gesamtbeurteilung

Anlage 1 (28 Seiten)

Ergebnis

Die Schlösser haben die **Klasse 3** gemäß DIN 18251-3 : 2002 –11 erreicht.

ift Rosenheim
09. März 2010

Christian Kehrer, Dipl.-Ing. (FH)
Prüfstellenleiter
ift Zentrum Türen, Tore, Sicherheit

Alexander Spreitzer
Prüfingenieur
ift Zentrum Türen, Tore, Sicherheit

10.5 PFB - Zertifikat

PFB Prüfzentrum für Bauelemente
 Dipl.-Ing. (FH) Rüdiger Müller

 Fenster · windows
 Rollläden · shutters
 Türen + Tore · doors
 Fassaden · curtain walling
 Baubeschlüsse · building hardware
PRÜFZEUGNIS Nr. 08/12-A400-Z1

Prüfung von Mehrfachverriegelungen nach

- DIN 18251-3 : 2002-11 „Schlösser, Einsteckschlösser – Teil 3: Einsteckschlösser als Mehrfachverriegelungen“
- DIN V ENV 1627 : 1999-04 „Fenster, Türen, Abschlüsse – Einbruchhemmung - Anforderungen und Klassifizierung“, Abschnitt 4.4 „Anforderungen an Beschläge“, „Schutz gegen Verschieben der Verriegelungszapfen“

Antragsteller
 Mayer & Co. Beschläge GmbH
 Alpenstraße 173
 A-5020 Salzburg
Bauart
 Mehrfachverriegelung bestehend aus
 Hauptschloss mit Kurbelfalle und Flachriegel,
 je eine Kurbelfalle oben und unten mit
 Fallensperre im verriegelten Zustand,
 je eine Pilzzapfenverriegelung oben und unten
 Flachstulp 16 x 3, 20 x 3, 24 x 3 (oder 24/16 x 3 mm),
 Dornmaß 35, 40, 45, 50, 55, 65, 70 oder 80 mm,
 Drückernusslochung 8 mm, (8,5 mm oder 9 mm)
 Profilzylinderlochung, Entfernung 92 mm (oder 85 mm,
 alternativ Rundzylinder mit Entfernung 94 mm)
 Ausführungen in Klammern sind von DIN 18251-3 abweichend
 gesondert zu vereinbaren.
**Produktbezeichnung**
MACO „PROTECT“ TÜRSCHLOSS Z-TF
 mit dazugehörigen Schließteilen EH für **2MF + 2i.S rechts/links**
Klassifizierung

Obige Bauart erfüllt gemäß Prüfbericht Nr. 09/12-A400-B1 vom 30.06.2009



- die Anforderungen der **DIN 18251-3 in der Klasse 3 mit Türanzug** mit abweichenden Maßen sowie einer erhöhten Fallenfederkraft. Durch die Kurbelfalle ergeben sich keine erhöhten Schließkräfte. Eine Kennzeichnung nach DIN 18251-3 ist nicht möglich



- die Anforderungen an den „**Widerstand gegen Verschieben des Verriegelungszapfens**“ gemäß Abschnitt 4.4 „Anforderungen an Beschläge“ mit Tabelle C1 der DIN V ENV 1627 : 1999-04 für den Einsatz in zu prüfenden Türen bis zur Widerstandsklasse **WK 2**.

Gültigkeit
 Laufzeit der DIN 18251-3 Ausgabe November 2002
 (Laufzeit der DIN V ENV 1627 Ausgabe April 1999)



 Dipl.-Ing. Arno Urban
 Stellvertretender Institutsleiter

 PFB GmbH & Co. Prüfzentrum für Bauelemente KG
 Lackermannweg 24
 D-83071 Stephanskirchen (bei Rosenheim)
 Gesellschafter M. Demmel, R. Müller, A. Urban
 AG Traunstein HRA 8871

30.06.2009

 Telefon +49 (0) 80 36 / 67 49 47 - 0
 Telefax +49 (0) 80 36 / 67 49 47 - 28
 www.pfb-rosenheim.de
 info@pfb-rosenheim.de



 Dipl.-Ing. Matthias Demmel
 Sachbearbeiter

 Sparkasse Rosenheim
 Bankleitzahl 711 500 00
 Kontonummer 500 556 741
 Steuer-Nr. 156/172/13009
 USt-IdNr. DE245353602

10.6 SKG - сертификат

SKG certificaat

420 . 212 . 01

Certificaathouder

Maco Beschläge Nederland BV
Stikkenweg 60 / Postbus 41
7020 AA Zelhem
T: +31 (0) 314 659 700
E: info@maco-nl.nl
I: www.maco-nl.nl

Bezoekadres

Nieuwe Kanaal 9F
Wageningen
Postadres
Postbus 362
6700 AJ Wageningen
T 0317 – 421 720
F 0317 – 421 677
E info@skg.nl
I www.skg.nl

| | |
|--|------------|
| Uitgiftedatum: | 1-jan-2011 |
| Controleer op www.sterrenwijzer.nl of dit certificaat nog geldig en actueel is | |

Verklaring van SKG

SKG verklaart, dat het door of voor de certificaathouder vervaardigde hang- en sluitwerkproduct:

meerpunts-smalslot met schootvangers

geleverd onder logo / merk:

MACO

geleverd onder typeaanduiding en artikelnummers:

Protect i.S.

voldoet aan klasse 2 STER volgens BRL 3104: 15-10-2010 en NEN 5089: 2009
mits het hiernaast afgebeelde SKG inbraakwerendheidsmerkteken onuitwisbaar
op het product is aangebracht



Wageningen, 1-jan-2011



ir. H.A.J. van Dartel
certificatiemanager

Op deze verklaring is van toepassing het SKG Reglement voor Productcertificatie 2006.

Geldigheid van deze verklaring:

Deze verklaring is geldig voor zover aan alle daarmee samenhangende verplichtingen is voldaan en voor zover om enigerlei reden niet eerder een einde is gekomen aan de geldigheidsduur.

De geldigheid vervalt in elk geval:

- na verbreking van de certificatie-overeenkomst;
- na intrekking van deze verklaring;
- na uitgifte van deze verklaring met recentere datum van uitgifte.



10.7 Общая продукт-информация

ОБЩАЯ ИНФОРМАЦИЯ О ПРОДУКЦИИ

Рекомендации по гарантии на продукцию

Многозапорные дверные замки

(общая информация о продукции)

Фурнитура дверных замков

В соответствии с установленной законом ответственностью производителя за выпускаемую им продукцию (§1 PHG) прилагаемая информация на программу дверных замков является обязательной и должна быть принята к сведению. Несоблюдение правил пользования освобождает производителя от гарантийных обязательств.

1. Информация о продукции

Правильное использование продукции

Фурнитуру дверных замков можно подразделить на фурнитуру (на створку и на коробку) для дверей из дерева, пластика и алюминия, а так же комбинаций перечисленных материалов.

Основные функции дверных замков:

запирание двери посредством защелки

блокировка двери на длительное время посредством ригелей, запорных цапф, штырей или крюков.

Каждый дверной замок фирмы MACO предлагается как многозапорный замок-защелка и применяется для системы запирания вертикально встроенных дверей. Программа дверных замков фирмы MACO предлагает две разные по способу срабатывания системы дверных замков:

1.1. Многозапорный дверной замок с приводом от дверной ручки – G-TS

При закрывании и блокировке двери с замком G-TS запирающие цапфы приводятся в движение нажатием ручки замка вверх. После закрывания дверной замок блокируется поворотом ключа на 360°. Дверная ручка блокируется и не поворачивается вниз, запорные элементы заблокированы. При повороте ключа в обратном направлении, замыкающий цилиндр возвращается в исходное положение, дверной замок G-TS разблокирован. Запирающие цапфы разблокированы. При повороте дверной ручки вниз, запирающие цапфы вместе с защелкой втягиваются в замок. Дверь вновь открыта.

Внимание! Для дверных замков G-TS нажимные гарнитуры устанавливаются с внешней и внутренней стороны двери.

1.2. Многозапорный дверной замок с приводом от цилиндра – Z-TS / Z-TF

Блокировка дверного замка Z-TS / Z-TF осуществляется двойным поворотом ключа на 360° в профильном цилиндре. При этом запорные элементы заходят в зацепление с ответными планками, таким образом, дверь заблокирована. Дверной замок Z-TS / Z-TF отпирается двойным поворотом ключа в обратном направлении. Дверная защелка при открывании может втягиваться внутрь замка, как при нажатии ручки, так и при помощи ключа через профильный цилиндр.

На многозапорных дверных замках с приводом от цилиндра – Z-TS / Z-TF, с внешней стороны двери возможно вмонтировать кнопку.

Многозапорные замки MACO применяются в комбинации с профильными цилиндрами согласно DIN 18254. Деревянные коробки соответствуют DIN 18252 / EN 1303. В особых случаях обработчик дверных замков MACO должен отдавать себе отчет в том, что выбранный им запорный цилиндр предназначен для предписанных конструкций и работа замков гарантируется в случае правильного применения.

2. Монтаж многозапорных замков

Монтаж многозапорных замков MACO обязаны проводить только квалифицированные специалисты. Дверные замки MACO должны свободно входить в фурнитурный паз, в места фрезерования для корпуса замка, механизмов привода крюков и штырей. Любая деталь, вставленная с усилием в фурнитурный паз, может нарушить функциональность всей системы замка.

Прикручивание шульпа дверного замка в фурнитурный паз надо производить только соответствующим инструментом (с функцией контроля усилия!)

Запорные планки (стандартные и противозломные) запорные планки, запорные планки для крюков и штырей) должны монтироваться так, чтобы вход запорных элементов (цапф, крюков и штырей) был беспрепятственным, а сами запорные элементы, выдвинутые полностью, не до упора доходили до ответных планок.

3. Применение с нарушением норм. Неправильное (ошибочное) использование

Пожалуйста, ознакомьтесь с возможными нарушениями норм и неправильным (ошибочным) применением, схематично приведенными на 3 стр.

Общая информация о продукции

Рекомендации по гарантии на продукцию



4. Уход за продукцией

Для того чтобы обеспечить безупречную работу многопозиционного замка-защёлки фирмы MASCO, следует:

доводить до сведения соответствующих лиц всю необходимую информацию и инструкции

учитывать соответствующие нормы

применять многозапорные дверные замки в соответствии с указанной функцией

соблюдать предписания изготовителя в отношении фурнитуры

выполнять инструкции по уходу и обслуживанию

производить ремонт только квалифицированными специалистами

5. Функциональность продукции

Так как работа нашей продукции конкретно не описывается в наших каталогах и проспектах, требования к отдельным частям замков должны согласовываться с нашей фирмой.

Данные относительно работы нашей продукции распространяются на комбинации деталей, произведенных на фирме MASCO. Пригодность к эксплуатации систем запираения зависит от частоты эксплуатации, способа эксплуатации, влияния окружающей среды, ухода и обслуживания.

**MACO
PROTECT**



MAYER & CO BESCHLÄGE GMBH

ALPENSTRASSE 173
A-5020 SALZBURG
TEL +43 (0)662 6196-0
FAX +43 (0)662 6196-1449
maco@maco.at
www.maco.at

MACO РОССИЯ

248033, Россия, Калуга
Тульское шоссе, 10
Тел.: +7 4842 71 51 00
maco@maco.ru
www.maco.ru